

# Denti ranghinatore

Tines for side delivery rakes

Dents pour rateaux faneurs

Federzinken für rechwender

Muelles para rastrillos hileradoras

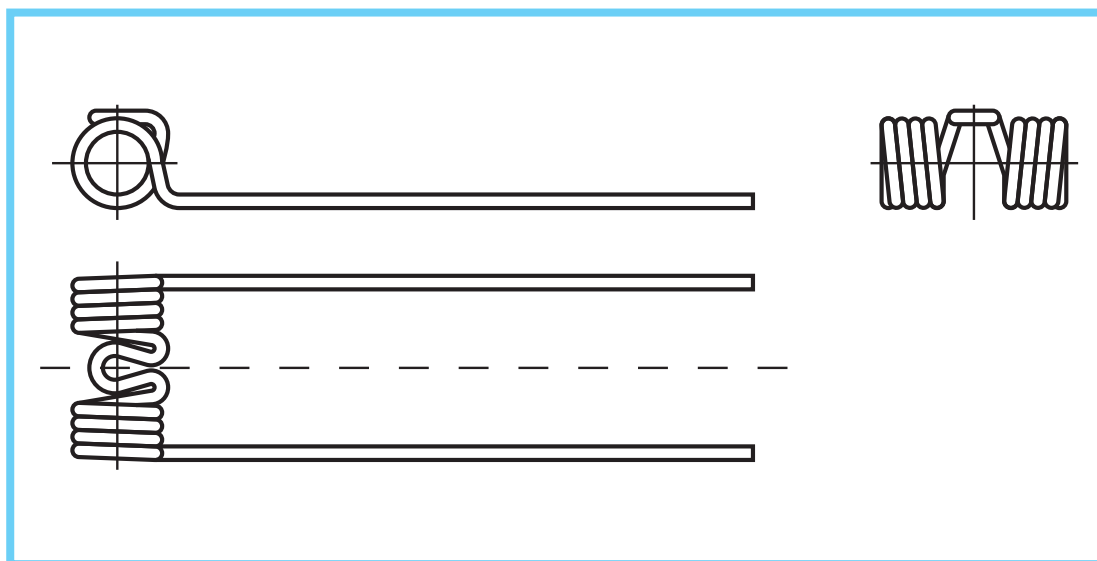

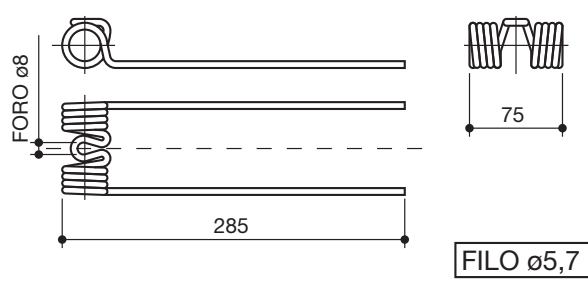
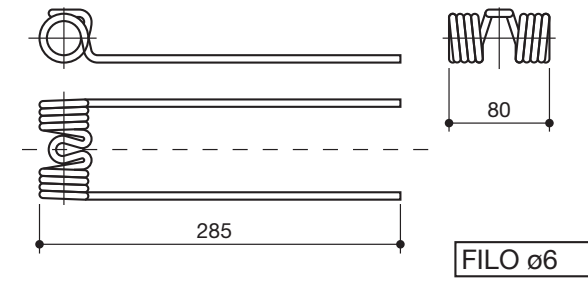
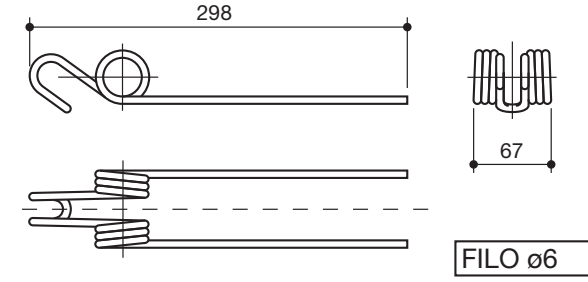
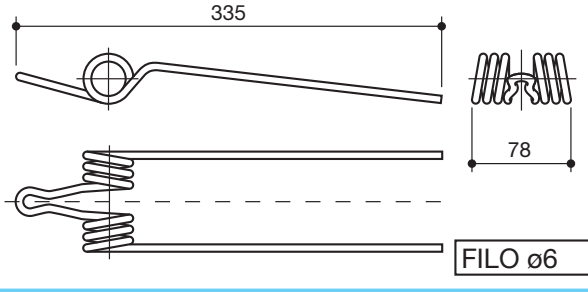
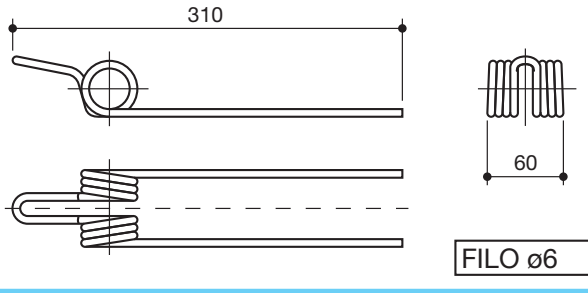
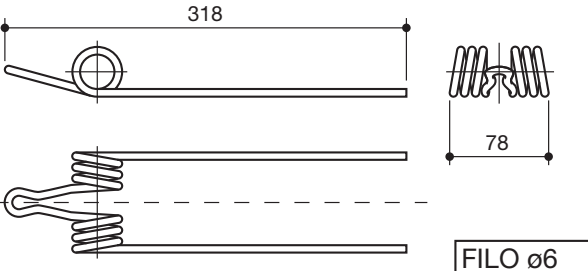
 <p>FORO ø8</p> <p>285</p> <p>75</p> <p>FILO ø5,7</p>	<p><b>BCS</b></p>	<p>LS10001</p>	<p>00311</p>
 <p>285</p> <p>80</p> <p>FILO ø6</p>	<p><b>BCS</b> filo 6</p>	<p>LS10002</p>	
 <p>298</p> <p>67</p> <p>FILO ø6</p>	<p><b>BUCHER</b></p>	<p>LS10003</p>	
 <p>335</p> <p>78</p> <p>FILO ø6</p>	<p><b>CANTONE</b> piegato</p>	<p>LS10004</p>	<p>MAB4</p>
 <p>310</p> <p>60</p> <p>FILO ø6</p>	<p><b>CANTONE</b> 1° tipo</p>	<p>LS10005</p>	<p>R3D</p>
 <p>318</p> <p>78</p> <p>FILO ø6</p>	<p><b>CANTONE</b> diritto</p>	<p>LS10006</p>	

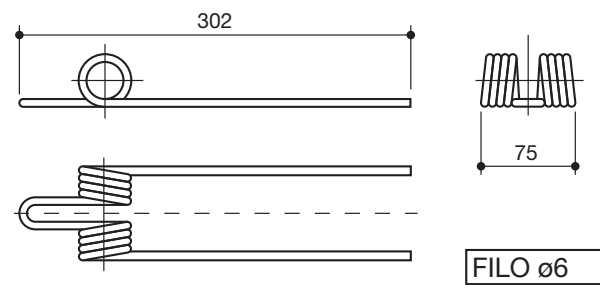

**CECCATO**

**LS10007**

**C063A**

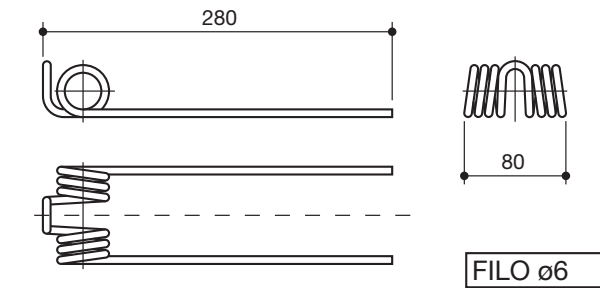

**CORMICK**

**LS10008**

**ICH 13553GA**

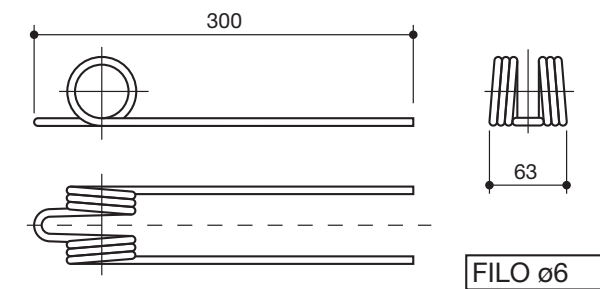

**DA ROS**

**LS10009**

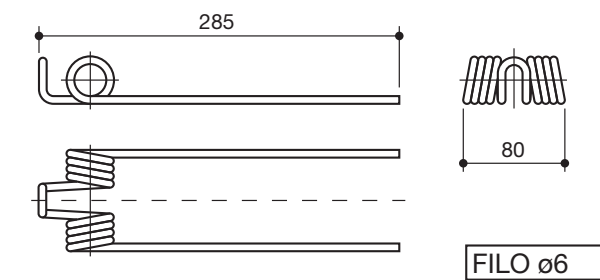

**FONTANESI**  
CORMICK

**LS10010**

**FF34**

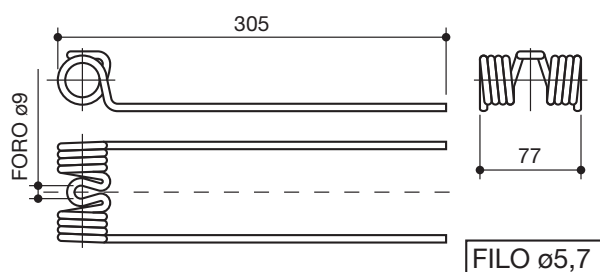

**FONTANESI**  
F9

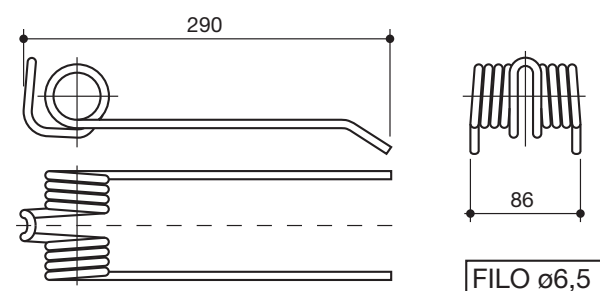

**LS10011**



**FONTANI**

**LS10012**

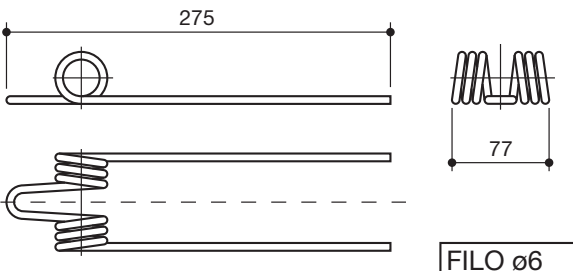
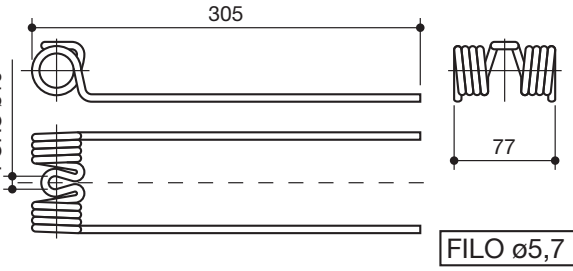
**RAP3**

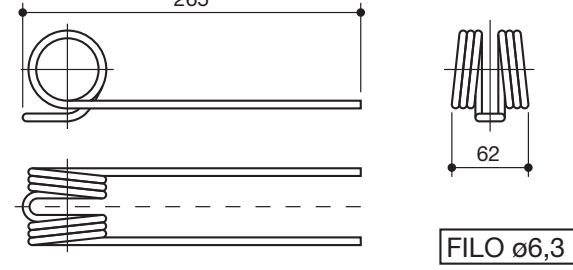
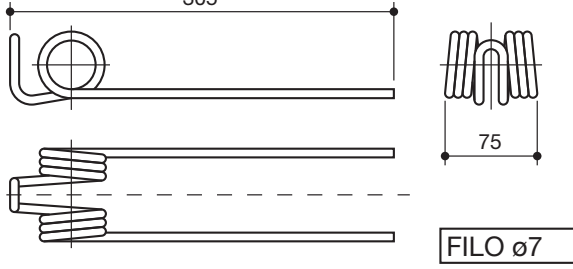
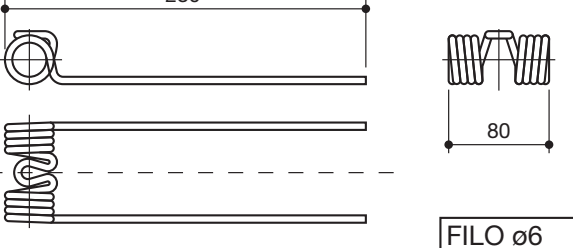
 <p>275</p> <p>77</p> <p>FILO ø6</p>	<p><b>FORT</b> F2</p>	<p>LS10013</p>	<p>F2/67</p>
 <p>305</p> <p>FORO ø10</p> <p>77</p> <p>FILO ø5,7</p>	<p><b>FORT</b> F3</p>	<p>LS10014</p>	<p>F3/67</p>
 <p>293</p> <p>77</p> <p>FILO ø5,7</p>	<p><b>FORT</b> F15</p>	<p>LS10015</p>	
 <p>265</p> <p>62</p> <p>FILO ø6,3</p>	<p><b>GASPARDO</b></p>	<p>LS10016</p>	<p>R01561</p>
 <p>305</p> <p>75</p> <p>FILO ø7</p>	<p><b>HAGEDORN</b></p>	<p>LS10017</p>	<p>SW1/ 57182</p>
 <p>280</p> <p>80</p> <p>FILO ø6</p>	<p><b>IMA</b> lungo</p>	<p>LS10018</p>	

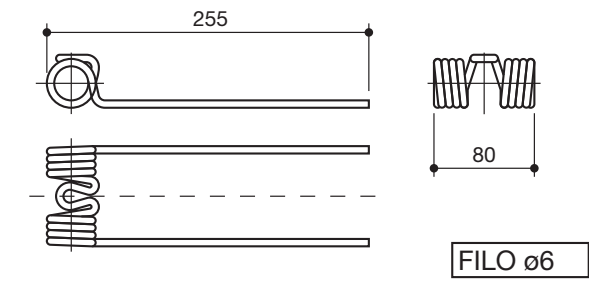
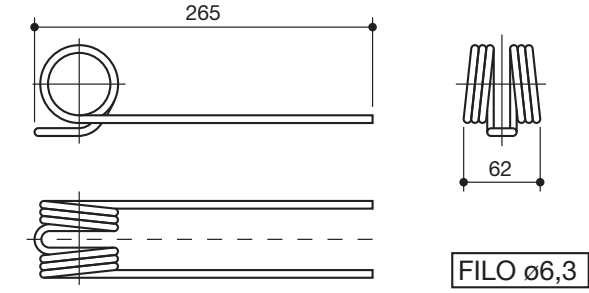
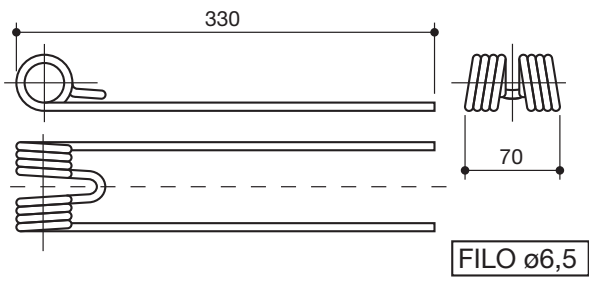
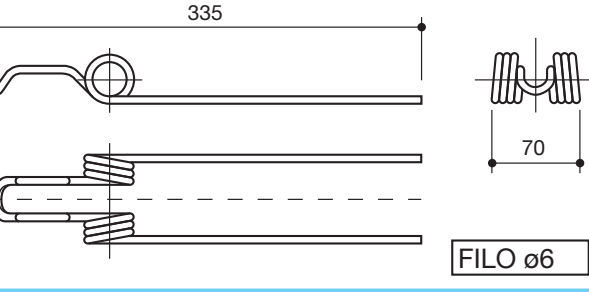
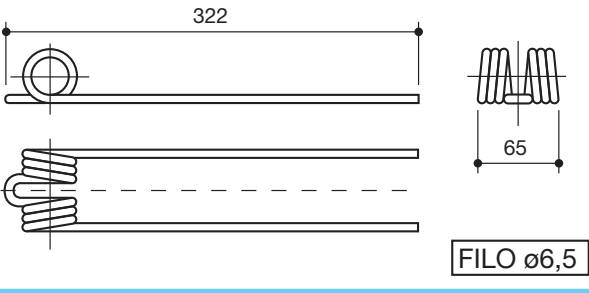
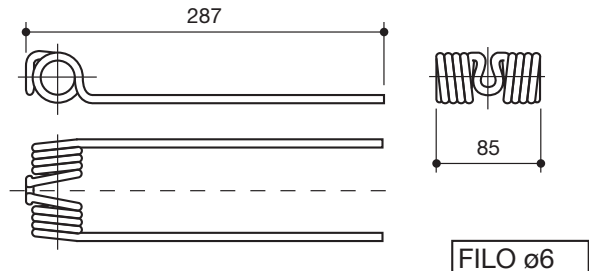
	<p><b>IMA</b> corto</p>	<p><b>LS10019</b></p>	
	<p><b>J.F.</b></p>	<p><b>LS10020</b></p>	<p><b>14330397</b></p>
	<p><b>KMF</b></p>	<p><b>LS10021</b></p>	<p><b>2130034</b></p>
	<p><b>LAVERDA</b> RV6</p>	<p><b>LS10022</b></p>	<p><b>60399</b></p>
	<p><b>LAVERDA</b> VELOX</p>	<p><b>LS10023</b></p>	<p><b>62071</b></p>
	<p><b>LINCE</b> TA</p>	<p><b>LS10024</b></p>	

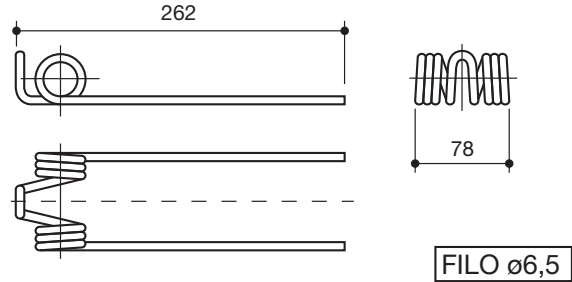
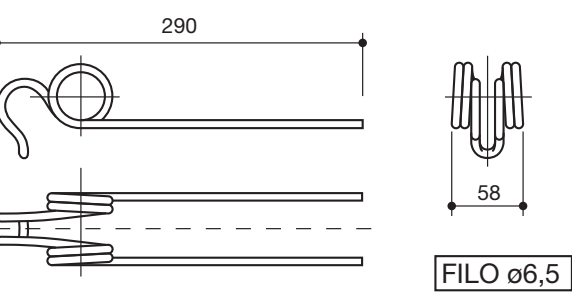
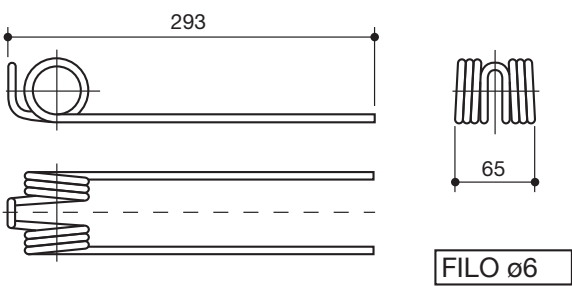
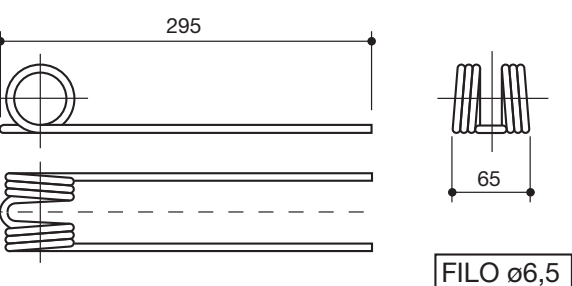
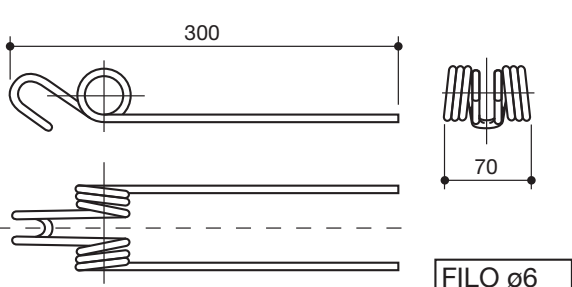
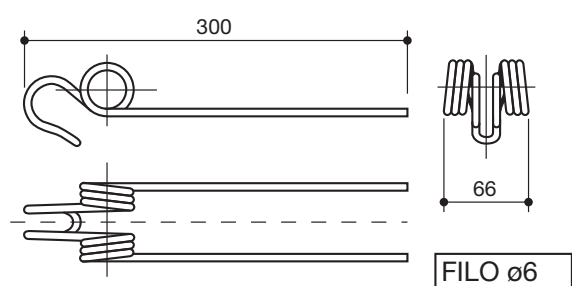
	<p><b>LINCE SUPER</b></p>	<p><b>LS10025</b></p>	
	<p><b>LINCE 1° tipo</b></p>	<p><b>LS10026</b></p>	
	<p><b>MOLON SPEEDY 1° tipo</b></p>	<p><b>LS10027</b></p>	
	<p><b>MOLON SPEEDY 2° tipo</b></p>	<p><b>LS10028</b></p>	
	<p><b>POTTINGER</b></p>	<p><b>LS10029</b></p>	<p><b>3220292A</b></p>
	<p><b>PRATER</b></p>	<p><b>LS10030</b></p>	

	<p><b>PZ 69</b></p>	<p>LS10031</p>	<p>PZ69</p>
	<p><b>NOVEX</b> piegato</p>	<p>LS10032</p>	<p>PZ316</p>
	<p><b>NOVEX</b> diritto</p>	<p>LS10033</p>	<p>PZ315</p>
	<p><b>REFORMWERKE</b></p>	<p>LS10034</p>	<p>MKW101122</p>
	<p><b>REPOSSI</b></p>	<p>LS10035</p>	<p>D0011/A</p>
	<p><b>REPOSSI</b> piegato</p>	<p>LS10036</p>	

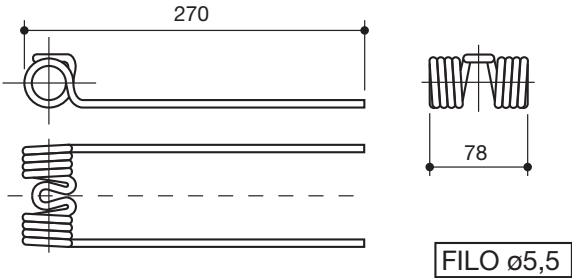
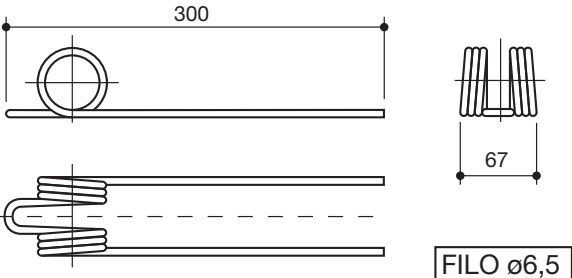
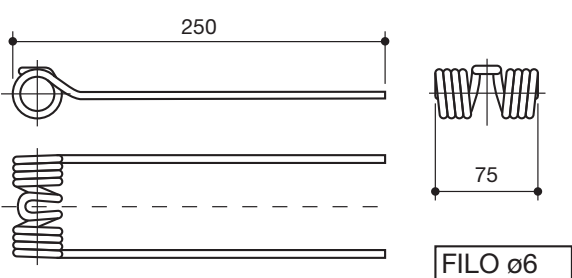
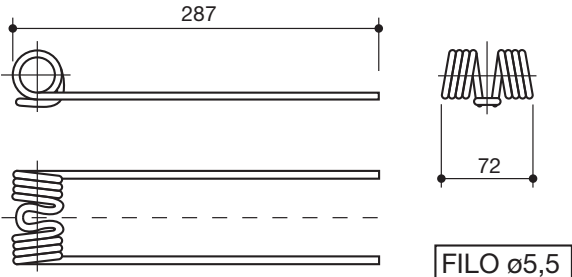
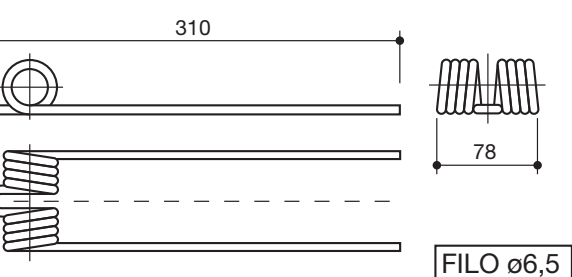
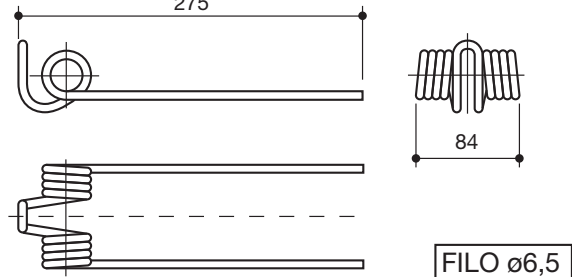
 <p>270</p> <p>78</p> <p>FILO ø5,5</p>	<p><b>SANTINI</b></p>	<p>LS10037</p>	
 <p>300</p> <p>67</p> <p>FILO ø6,5</p>	<p><b>SIGMA</b> a nastro</p>	<p>LS10038</p>	
 <p>250</p> <p>75</p> <p>FILO ø6</p>	<p><b>SICMA</b> a pettine</p>	<p>LS10039</p>	
 <p>287</p> <p>72</p> <p>FILO ø5,5</p>	<p><b>SLAM</b> COLIBRI'</p>	<p>LS10040</p>	
 <p>310</p> <p>78</p> <p>FILO ø6,5</p>	<p><b>VOGEL NOOT</b></p>	<p>LS10041</p>	<p>F58007</p>
 <p>275</p> <p>84</p> <p>FILO ø6,5</p>	<p><b>VORAS</b> UNIVERSAL</p>	<p>LS10042</p>	

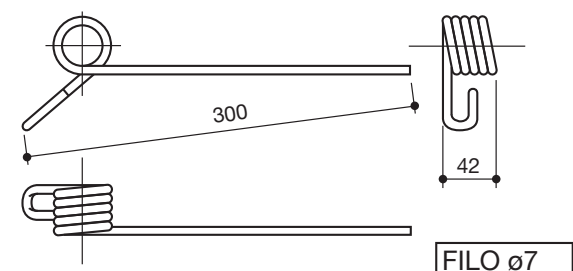
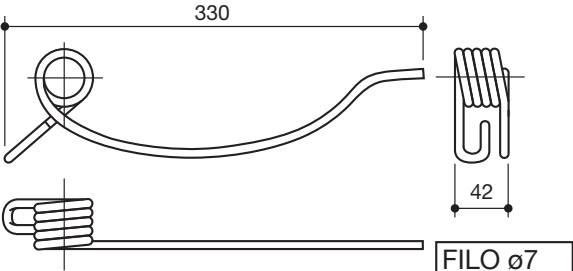
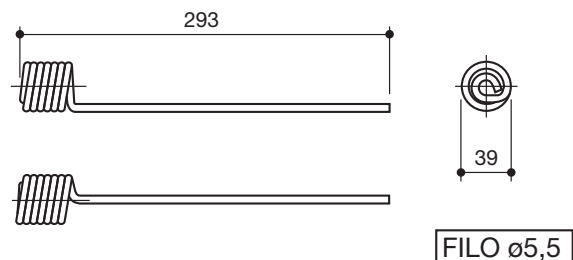
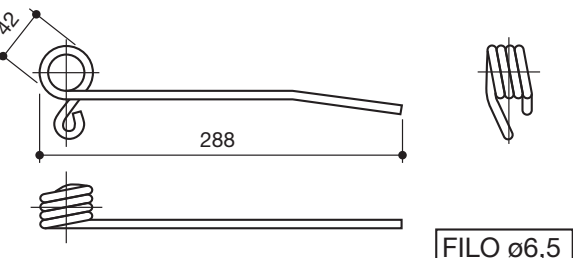
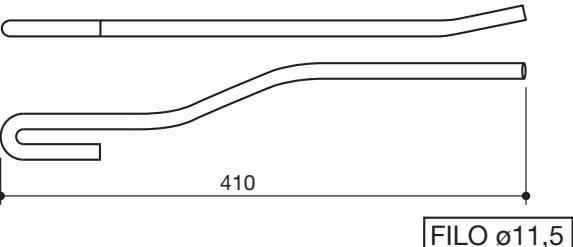
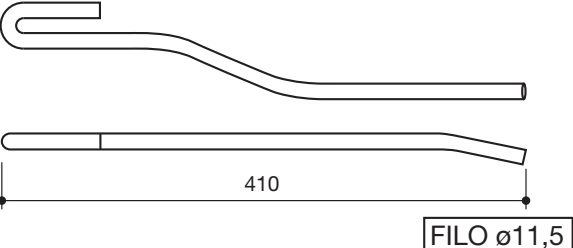

	<p><b>ZEWÉ NIEMEYER</b> diritto</p>	<p><b>LS10043</b></p>	
	<p><b>ZEWÉ NIEMEYER</b> piegato</p>	<p><b>LS10044</b></p>	
	<p><b>OLIVI</b> semplice</p>	<p><b>LS10045</b></p>	
	<p><b>BELLONI REPOSSI</b> semplice</p>	<p><b>LS10046</b></p>	
	<p><b>VICON</b> RC 300</p>	<p><b>LS10047</b></p>	<p><b>90036190</b></p>
	<p><b>VICON</b> RC 300</p>	<p><b>LS10048</b></p>	<p><b>90036191</b></p>

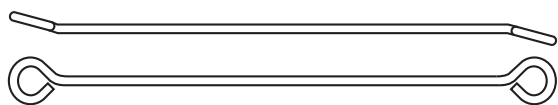

**MOLLA  
GUIDAFILO**

LS10049

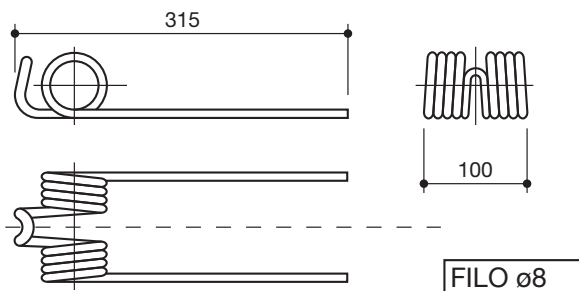

**BICIEFFE**  
1° tipo

LS10050

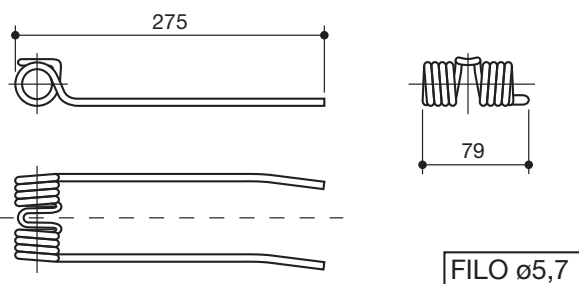

**REPOSSI**  
piagato dx

LS10051

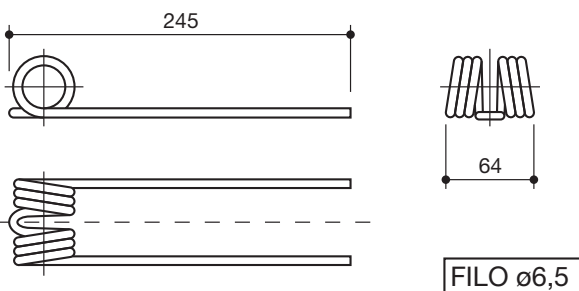

**RAPID**

LS10052

51280

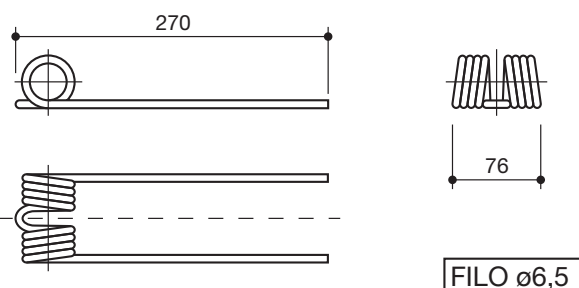

**VOGEL NOOT**

LS10053

58008

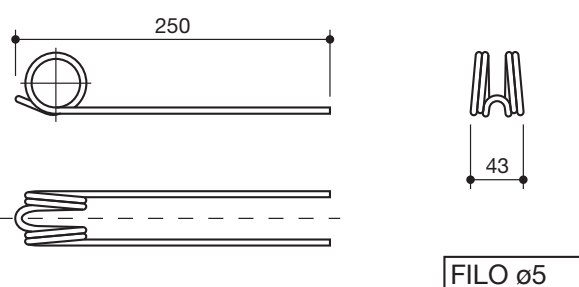

**MOLON**  
piccolo

LS10054

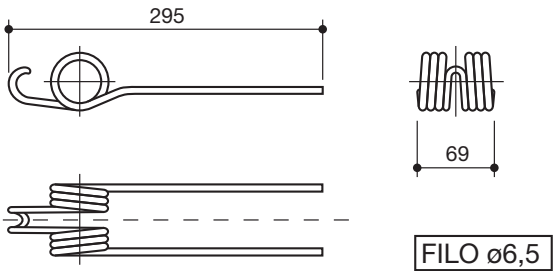
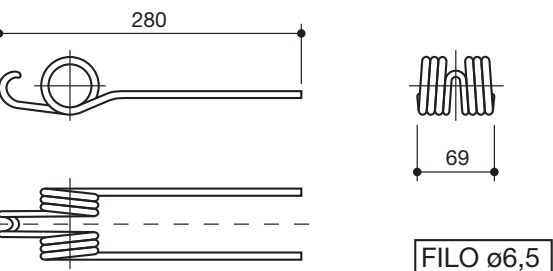
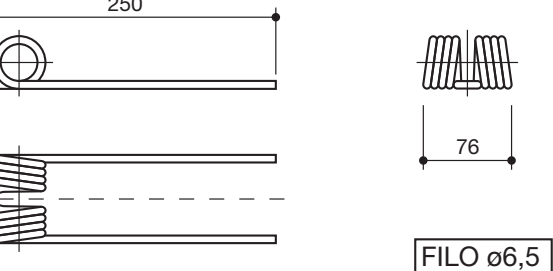
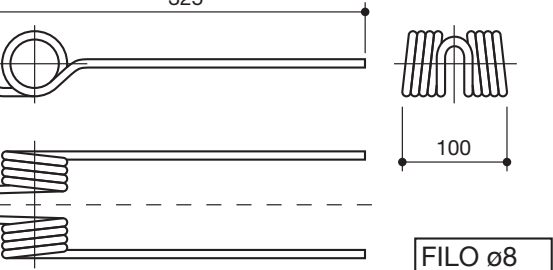
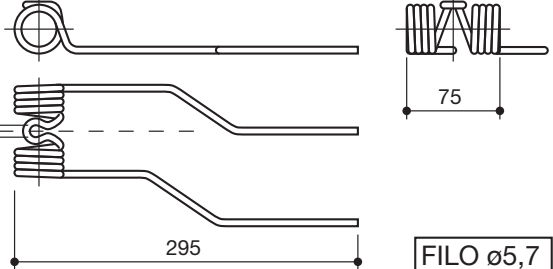
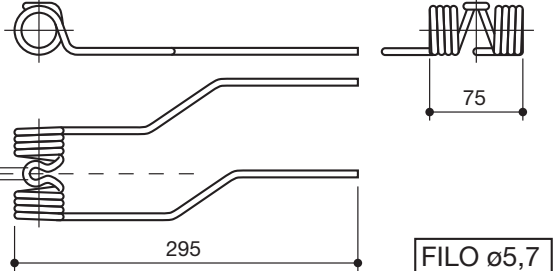
	<p><b>REFORMWERKE</b></p>	<p><b>LS10055</b></p>	<p><b>16420108</b></p>
	<p><b>REFORMWERKE</b></p>	<p><b>LS10056</b></p>	<p><b>16420109</b></p>
	<p><b>VOGEL NOOT</b></p>	<p><b>LS10057</b></p>	<p><b>F7508008</b></p>
	<p><b>BICIEFFE</b> 2° tipo</p>	<p><b>LS10058</b></p>	
	<p><b>BCS</b> laterale destra</p>	<p><b>LS10059</b></p>	
	<p><b>BCS</b> laterale sinistra</p>	<p><b>LS10060</b></p>	

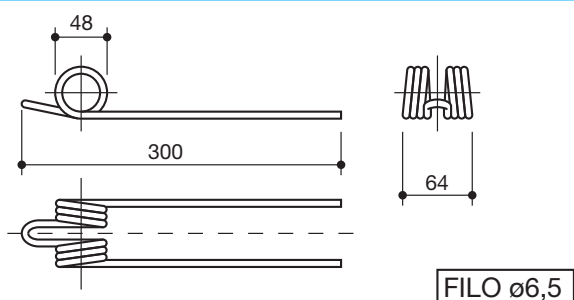

**XOTTA**  
lungo

LS10061

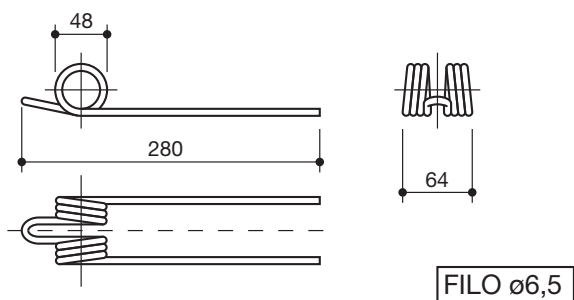

**XOTTA**  
corto

LS10062

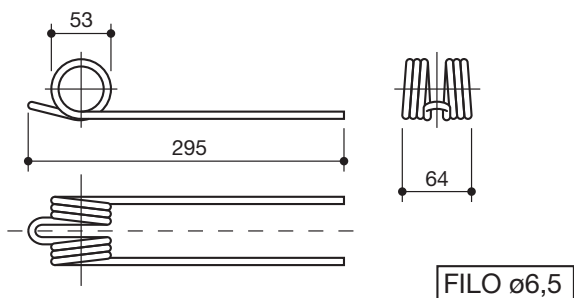

**MORELLATO**

LS10063

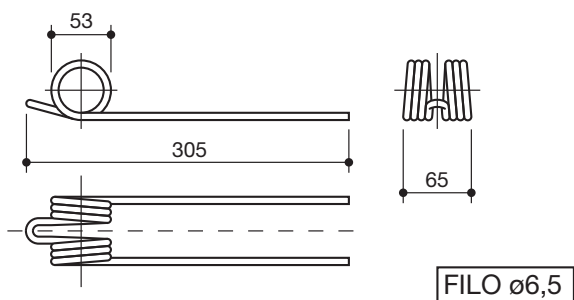

**CECCATO**  
2° tipo

LS10064

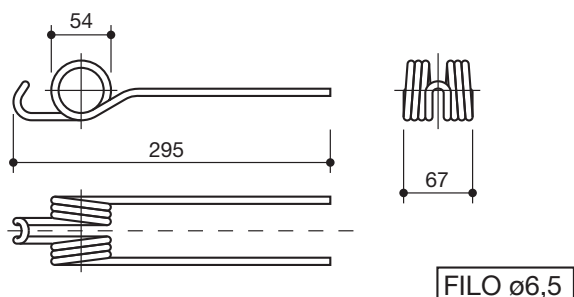

**REFORMWERKE**

LS10065

160420902

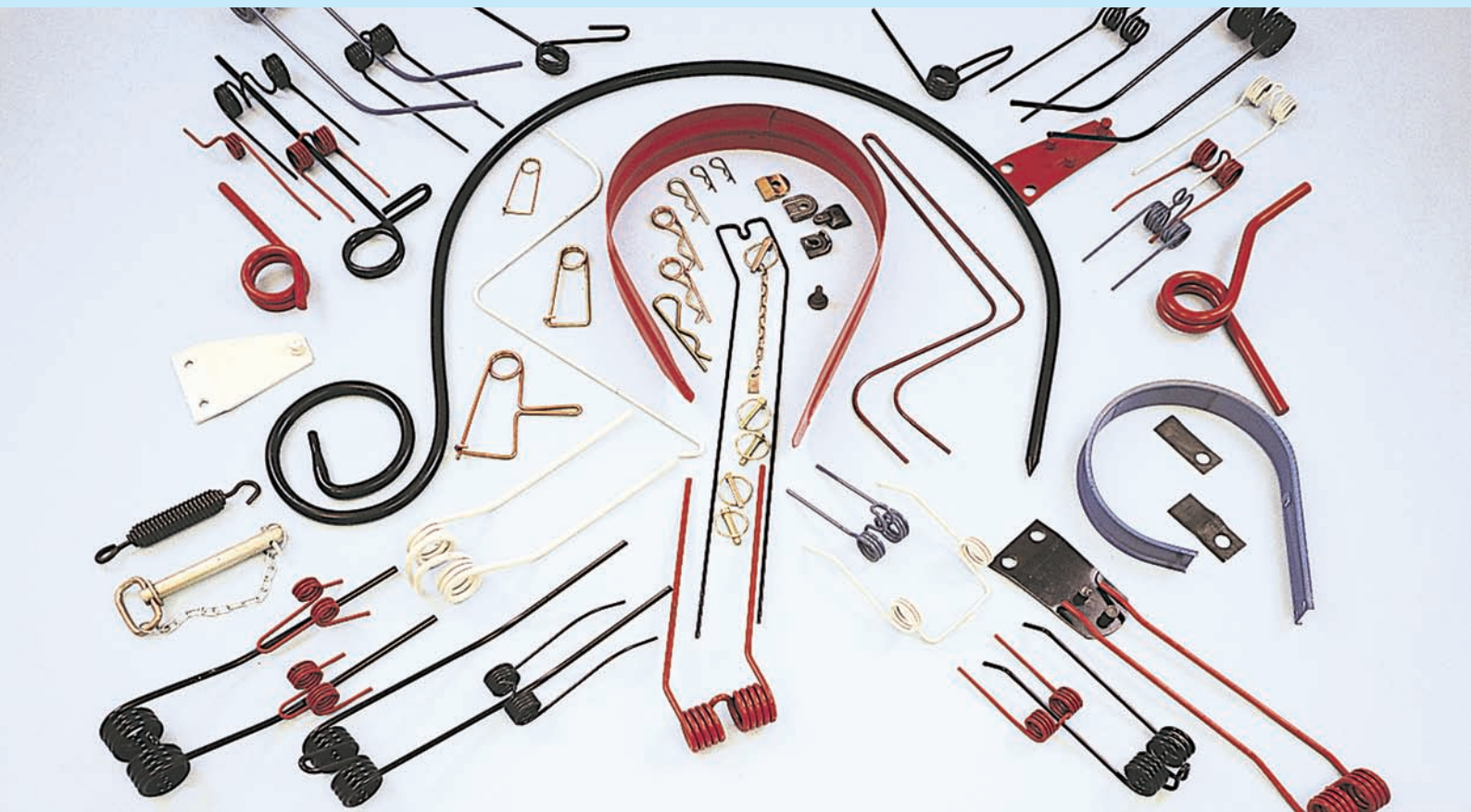

**LA SPIRALE** srl  
via Milano, 8 - 20084 Lacchiarella (MI) - ITALY  
tel. +39 02 90076666 +39 02 9008095  
fax +39 02 9007338  
www.laspiralemolle.it - e-mail: laspirale@tin.it