

40

Denti girello

Tines for rotary hay tedders

Dents pour faneuses

Federzinken für kreiselzettwender

Muelles para rastrillos volteadores

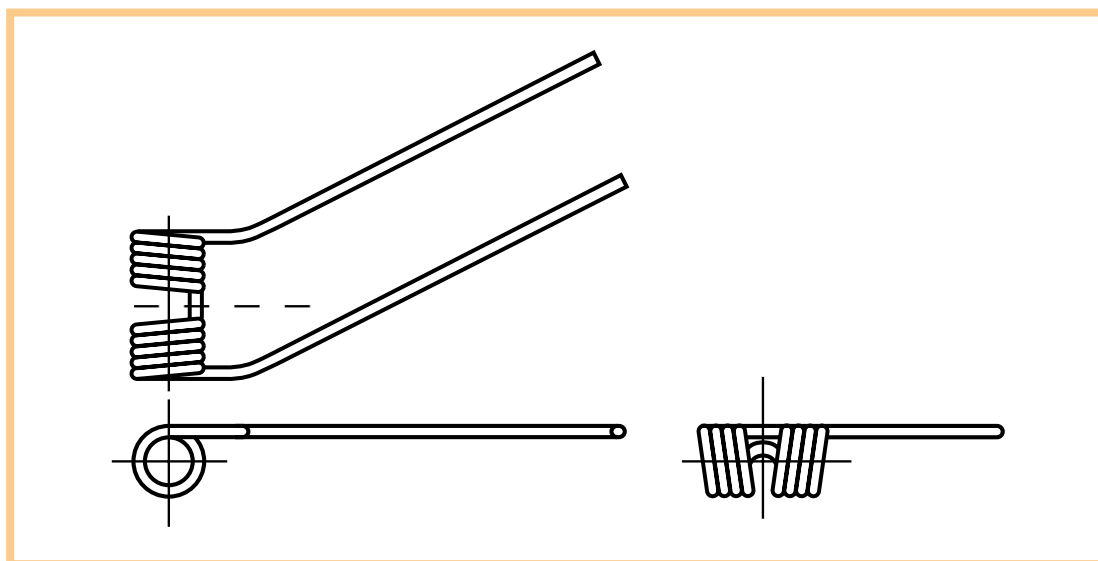

denti girello
tines for rotary hay tedders

denominazione
denomination

rif.
la spirale

rif.
originale

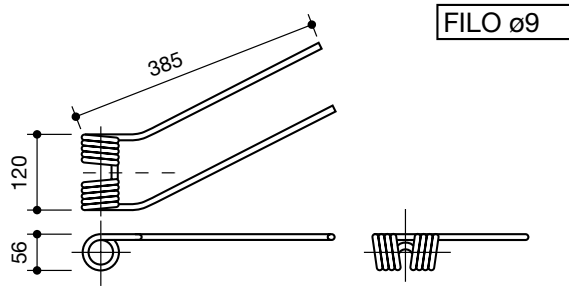

BAUTZ
destro

LS40001

26050015
926350

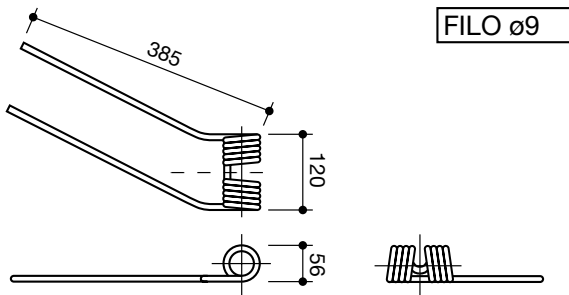

BAUTZ
sinistro

LS40002

26100004
926371

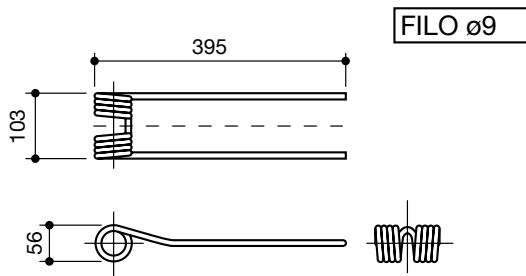

BCS

LS40003

4036

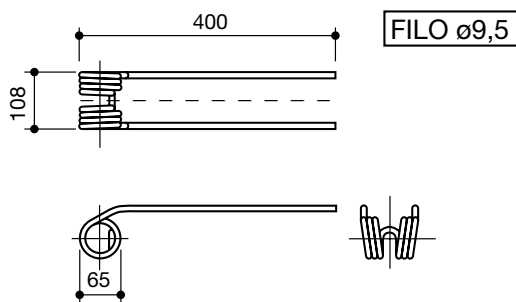

BUCHER

LS40004

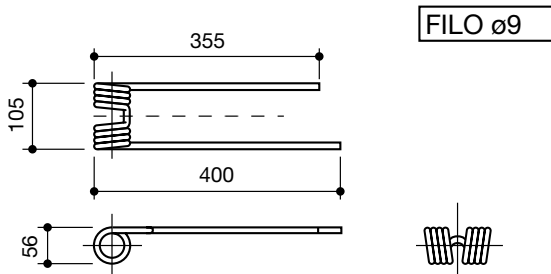

CECCATO
destro

LS40005

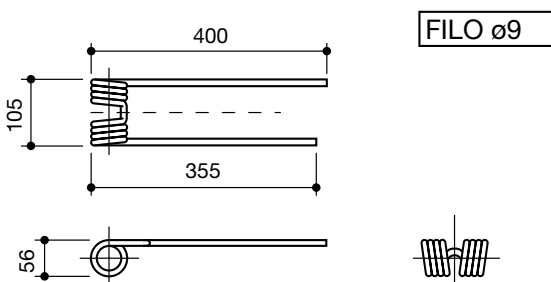

CECCATO
sinistro

LS40006

denti girello
tines for rotary hay tedders

denominazione
denomination

rif.
la spirale

rif.
originale

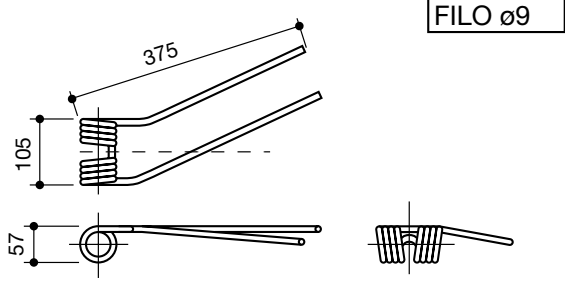
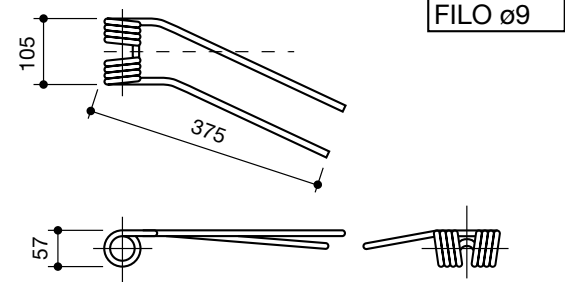
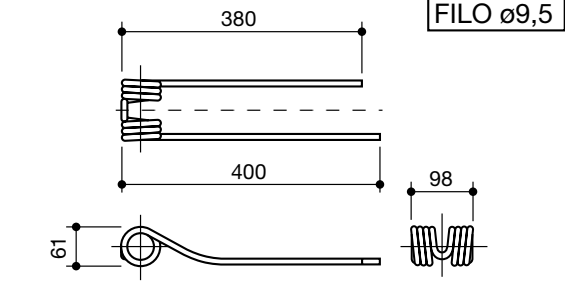
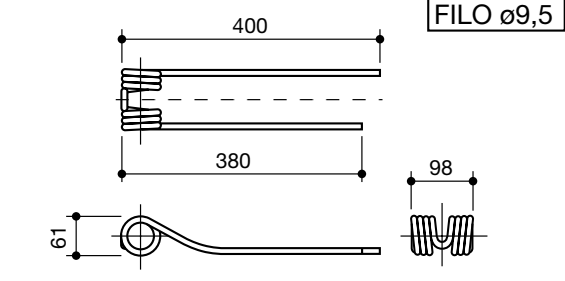
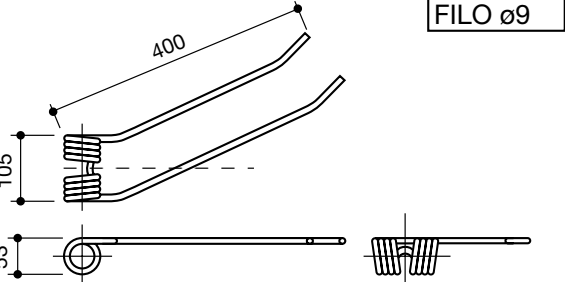
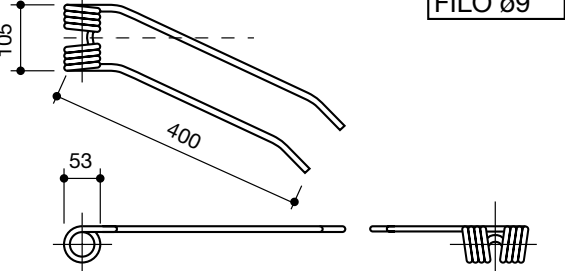
 <p>FILO ø9</p>	<p>COMA destro</p>	<p>LS40007</p>	
 <p>FILO ø9</p>	<p>COMA sinistro</p>	<p>LS40008</p>	
 <p>FILO ø9,5</p>	<p>CLAAS destro</p>	<p>LS40009</p>	<p>902483</p>
 <p>FILO ø9,5</p>	<p>CLAAS sinistro</p>	<p>LS40010</p>	<p>902482</p>
 <p>FILO ø9</p>	<p>DECENTRAITER destro</p>	<p>LS40011</p>	
 <p>FILO ø9</p>	<p>DECENTRAITER sinistro</p>	<p>LS40012</p>	

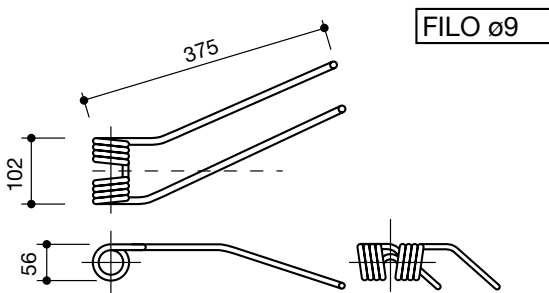
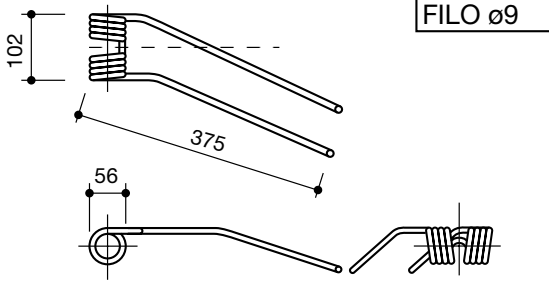
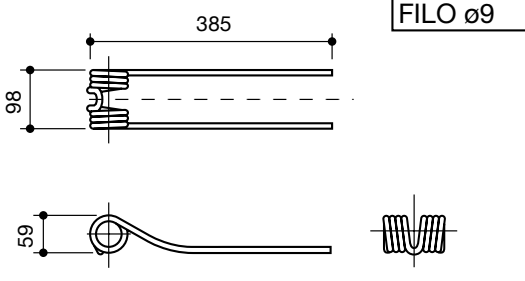
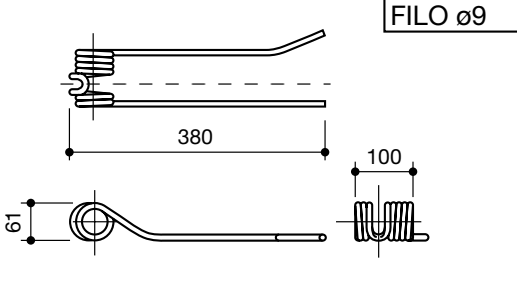
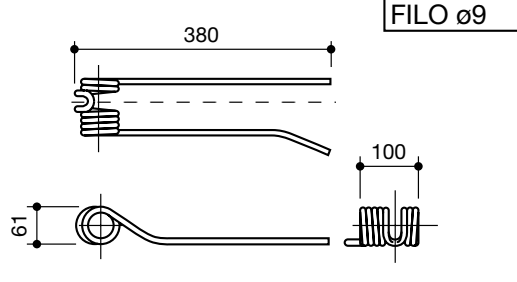
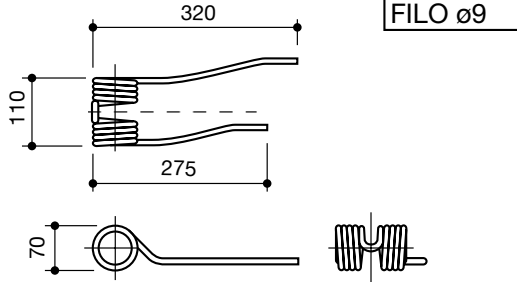
denti girello tines for rotary hay tedders	denominazione denomination	rif. la spirale	rif. originale
 <p>FILO ø9</p>	FAHR destro	LS40013	06580391 1104000150110
 <p>FILO ø9</p>	FAHR sinistro	LS40014	06229776 1104000150010
 <p>FILO ø9</p>	FAHR TN	LS40015	06580456 1104303010700
 <p>FILO ø9</p>	FAHR	LS40016	06580647 1106403012900
 <p>FILO ø9</p>	FAHR	LS40017	06580648 1106403013000
 <p>FILO ø9</p>	FARENDLOSE destro	LS40018	005110067

denti girello
tines for rotary hay tedders

denominazione
denomination

rif.
la spirale

rif.
originale

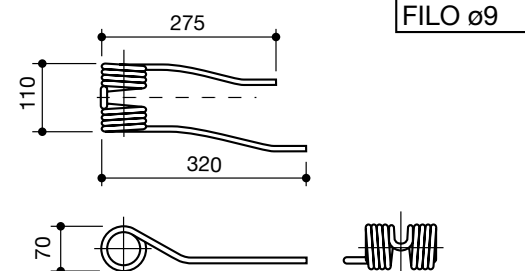
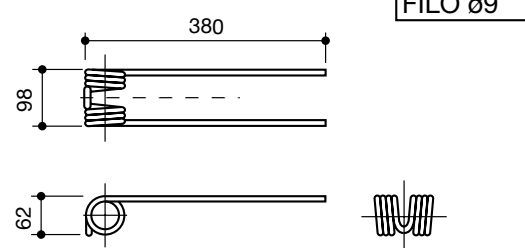
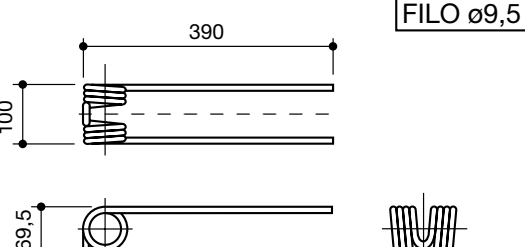
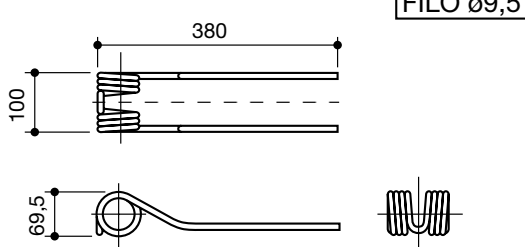
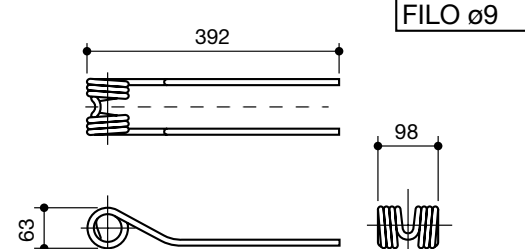
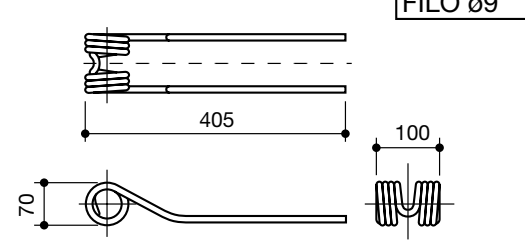
 <p>FILO ø9</p>	<p>FARENDLOSE sinistro</p>	<p>LS40019</p>	<p>005110066</p>
 <p>FILO ø9</p>	<p>FELLA</p>	<p>LS40020</p>	<p>487381</p>
 <p>FILO ø9,5</p>	<p>FELLA</p>	<p>LS40021</p>	<p>487734</p>
 <p>FILO ø9,5</p>	<p>FELLA</p>	<p>LS40022</p>	<p>150862 487922</p>
 <p>FILO ø9</p>	<p>FONTANESI 1° tipo</p>	<p>LS40023</p>	
 <p>FILO ø9</p>	<p>FONTANESI 2° tipo</p>	<p>LS40024</p>	

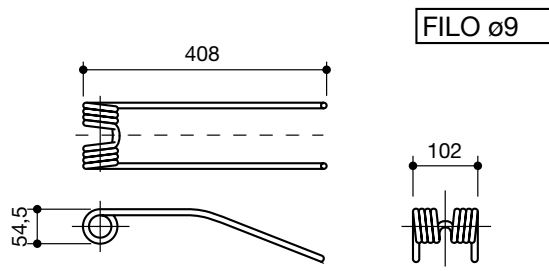
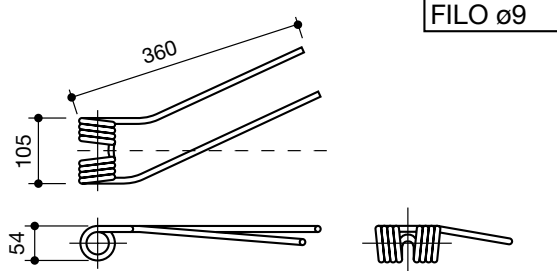
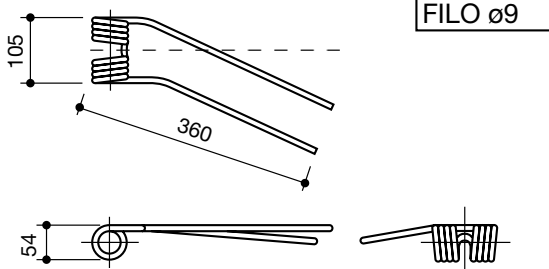
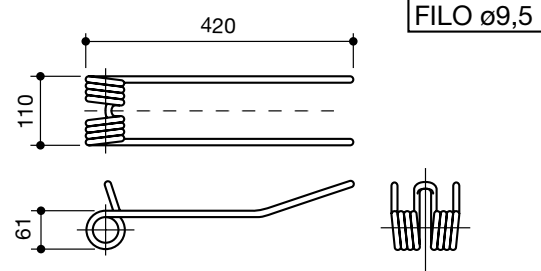
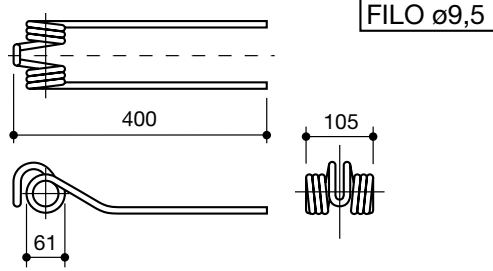
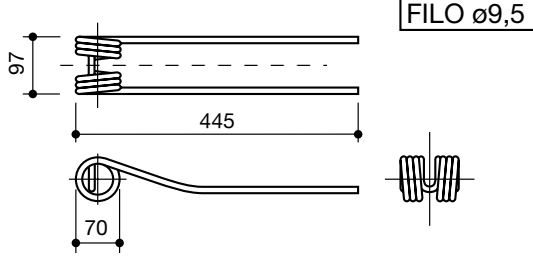
denti girello tines for rotary hay tedders	denominazione denomination	rif. la spirale	rif. originale
 <p>FILO Ø9</p>	FORT	LS40025	
 <p>FILO Ø9</p>	GALFRÈ destro	LS40026	108SV
 <p>FILO Ø9</p>	GALFRÈ sinistro	LS40027	107SV
 <p>FILO Ø9,5</p>	GALFRÈ GTS	LS40028	38
 <p>FILO Ø9,5</p>	GALFRÈ 87	LS40029	67/87
 <p>FILO Ø9,5</p>	GALFRÈ 88 1° tipo	LS40030	67/88

denti girello
tines for rotary hay tedders

denominazione
denomination

rif.
la spirale

rif.
originale

40

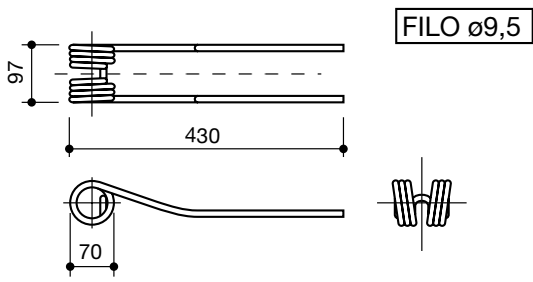
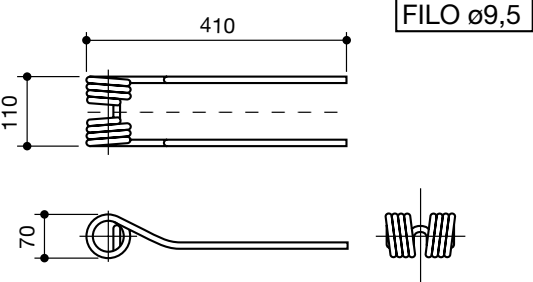
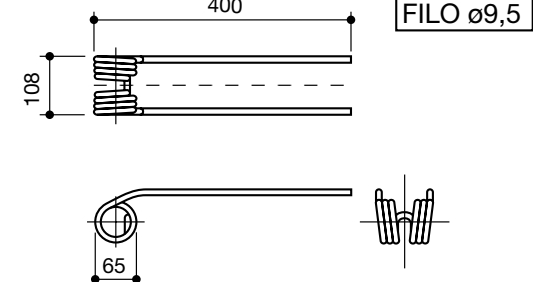
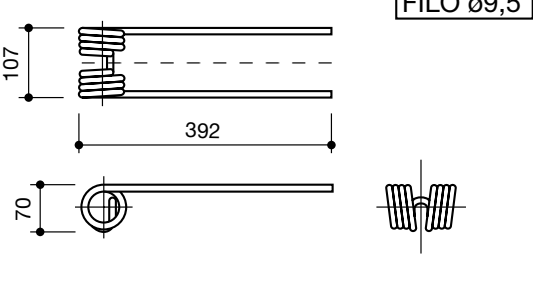
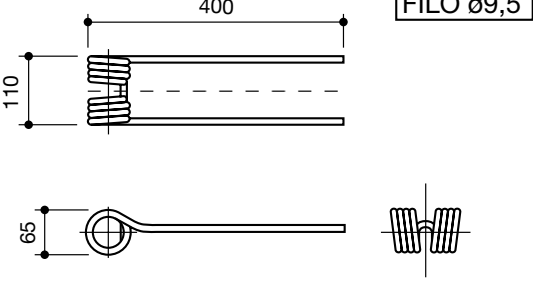
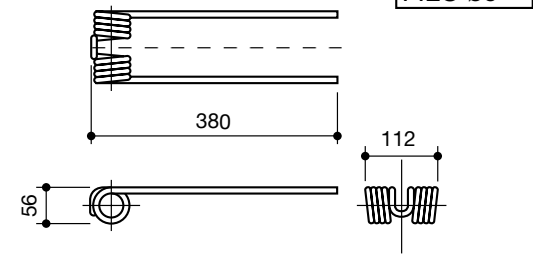
	<p>GALFRÈ 88 2° tipo</p>	<p>LS40031</p>	<p>67/88</p>
	<p>GALFRÈ 92</p>	<p>LS40032</p>	<p>67/46</p>
	<p>KUHN</p>	<p>LS40033</p>	<p>58505214 58505210</p>
	<p>KUHN</p>	<p>LS40034</p>	<p>58561900</p>
	<p>KUHN</p>	<p>LS40035</p>	<p>57609000</p>
	<p>ITALOSVIZZERA</p>	<p>LS40036</p>	

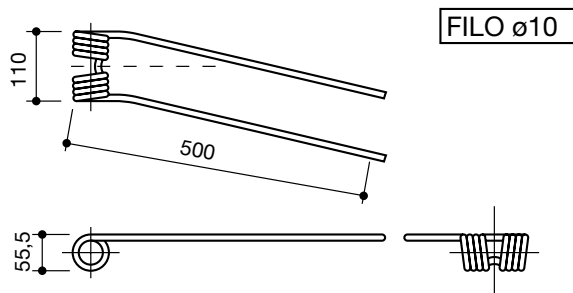
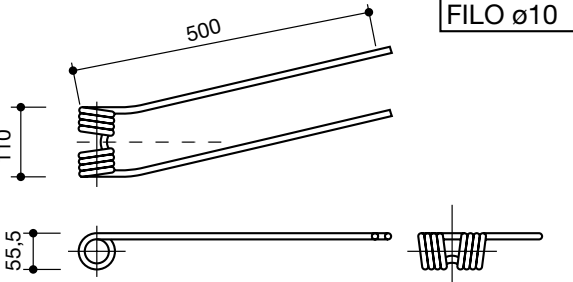
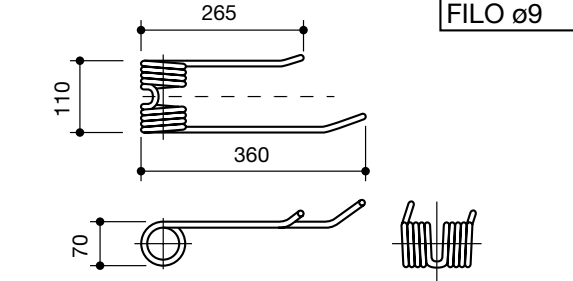
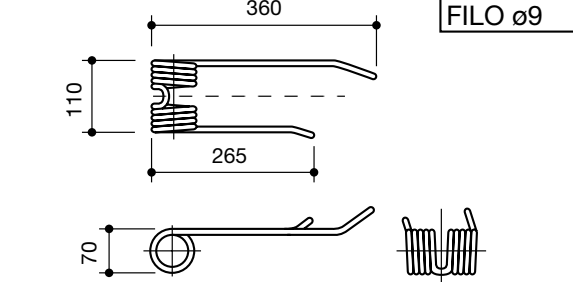
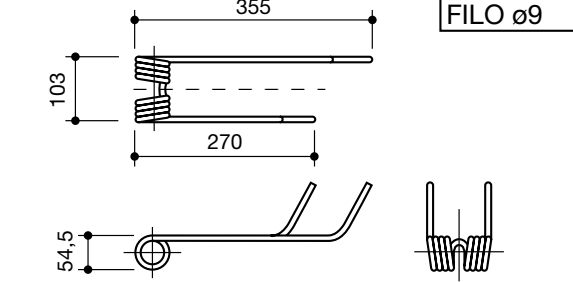
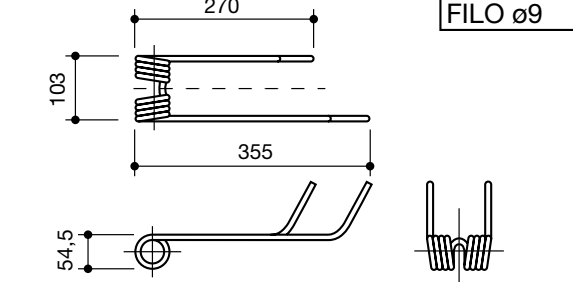
denti girello tines for rotary hay tedders	denominazione denomination	rif. la spirale	rif. originale
	JOHN DEERE destro	LS40037	A175664X
	JOHN DEERE sinistro	LS40038	A17564AX
	JF	LS40039	14330200R
	JF	LS40040	14330201L
	LELY	LS40041	SK1672 41003208L
	LELY	LS40042	SK1673 41003208R

denti girello
tines for rotary hay tedders

denominazione
denomination

rif.
la spirale

rif.
originale

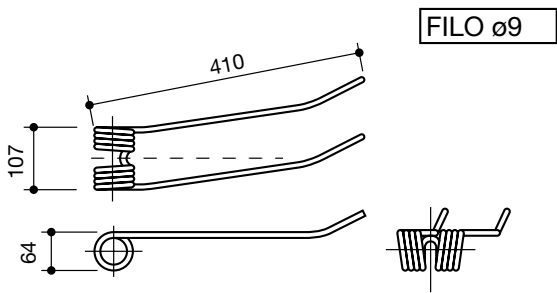

LELY
GEMINI
destro

LS40043

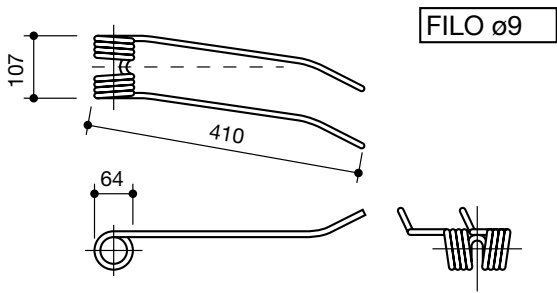

LELY
GEMINI
sinistro

LS40044

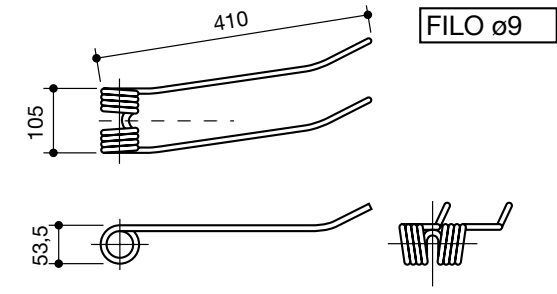

LELY
destro

LS40045

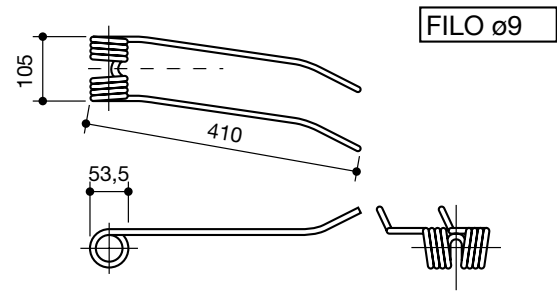

LELY
sinistro

LS40046

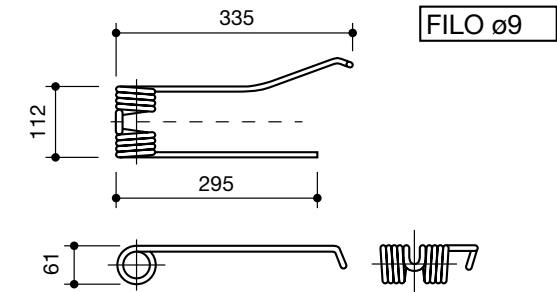

LELY

LS40047

73130

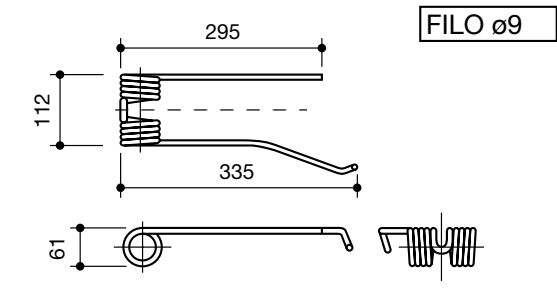

LELY

LS40048

73135

denti girello
tines for rotary hay tedders

denominazione
denomination

rif. la spirale

rif. originale

	<p>LELY</p>	<p>LS40049</p>	<p>4101500580L</p>
	<p>LELY</p>	<p>LS40050</p>	<p>4101500680R</p>
	<p>LERDA destro</p>	<p>LS40051</p>	
	<p>LERDA sinistro</p>	<p>LS40052</p>	
	<p>LINCÉ 38 destro</p>	<p>LS40053</p>	
	<p>LINCÉ 38 sinistro</p>	<p>LS40054</p>	

denti girello
tines for rotary hay tedders

denominazione
denomination

rif.
la spirale

rif.
originale

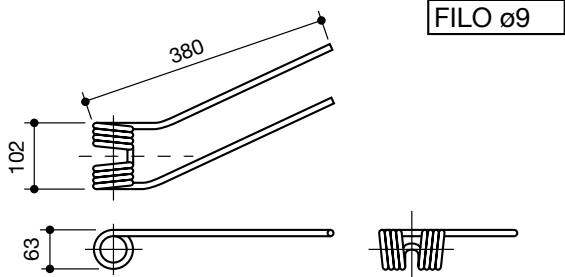

LINCE
44 destro

LS40055

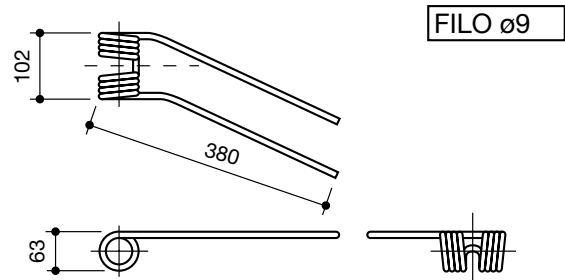

LINCE
44 sinistro

LS40056

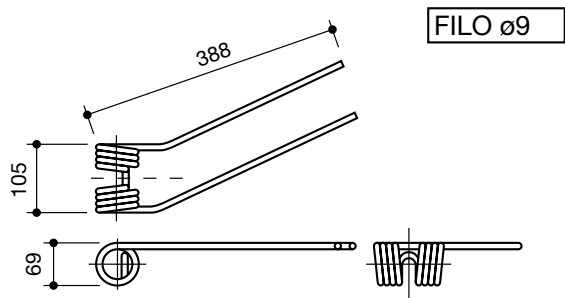

LINCE
51 destro

LS40057

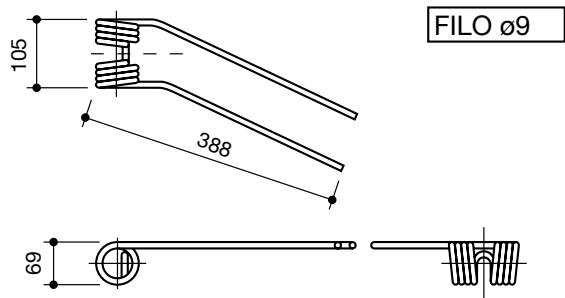

LINCE
51 sinistro

LS40058

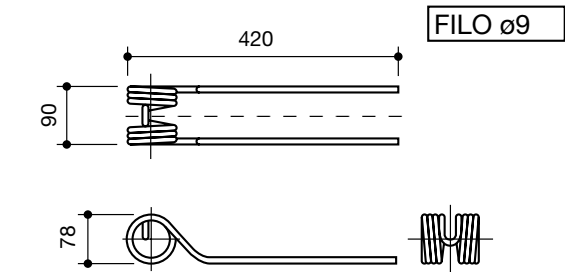

LINCE

LS40059

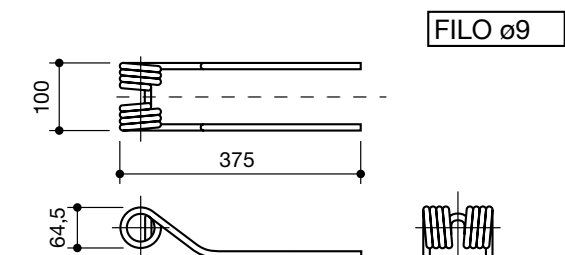

MARANGON

LS40060

000000290

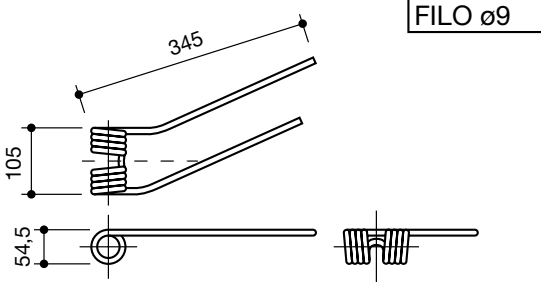
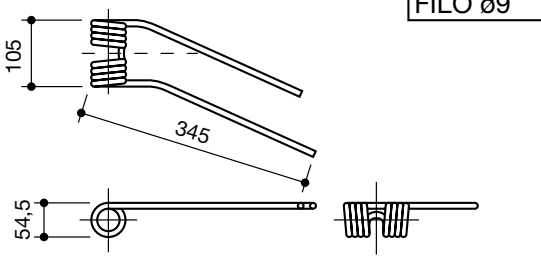
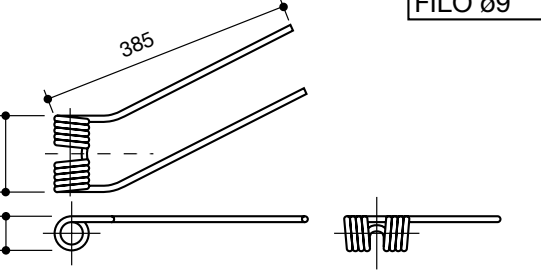
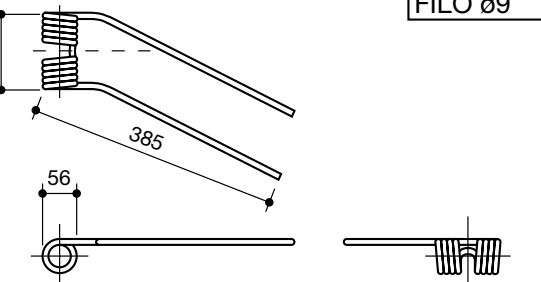
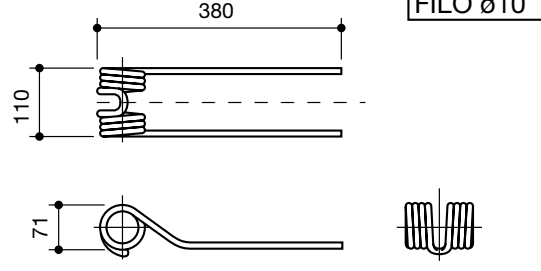
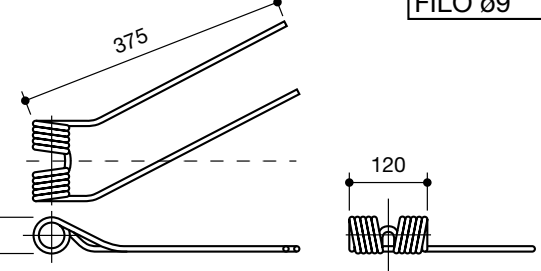
denti girello tines for rotary hay tedders	denominazione denomination	rif. la spirale	rif. originale
	MORRA 1° tipo destro	LS40061	
	MORRA 1° tipo sinistro	LS40062	
	MORRA 2° tipo destro	LS40063	
	MORRA 2° tipo sinistro	LS40064	
	MORRA filo 10	LS40065	MH420-530
	NIEMEYER	LS40066	10502

denti girello
tines for rotary hay tedders

denominazione
denomination

rif.
la spirale

rif.
originale

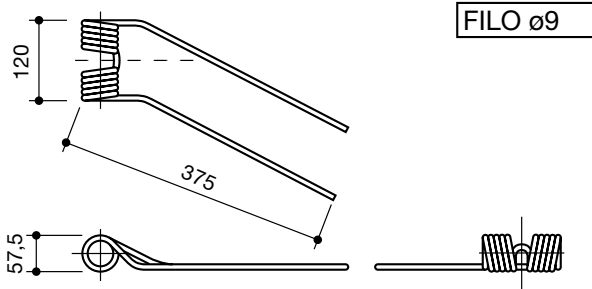

NIEMEYER

LS40067

10501

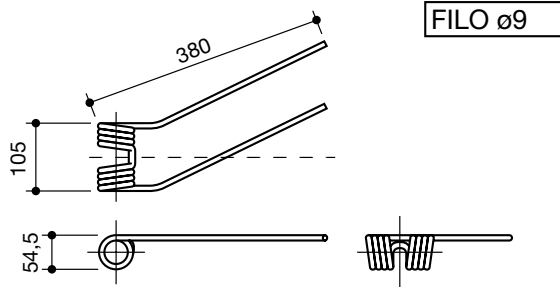

OKOENIG
destro

LS40068

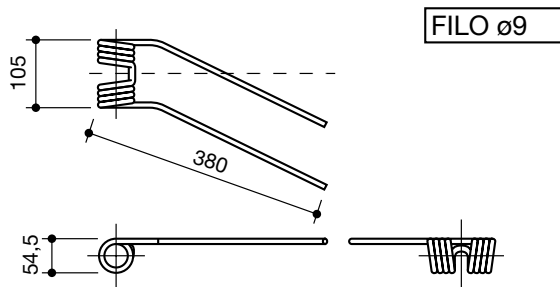

OKOENIG
sinistro

LS40069

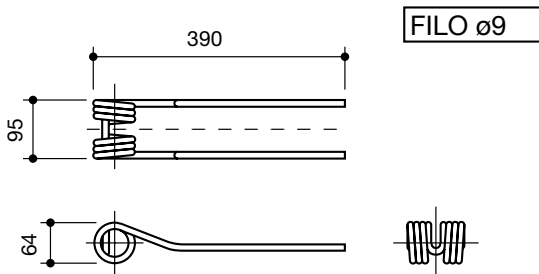

OLIVI
1° tipo

LS40070

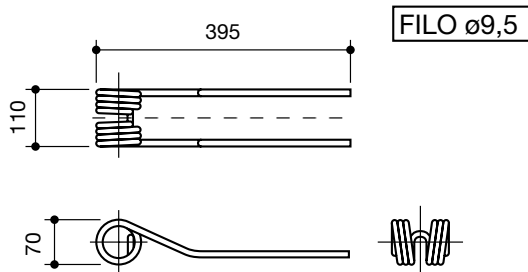

OLIVI
2° tipo

LS40071

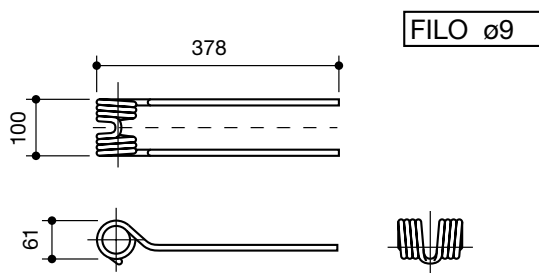

POTTINGER

LS40072

436014

40

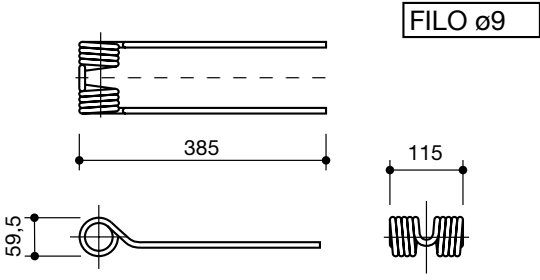
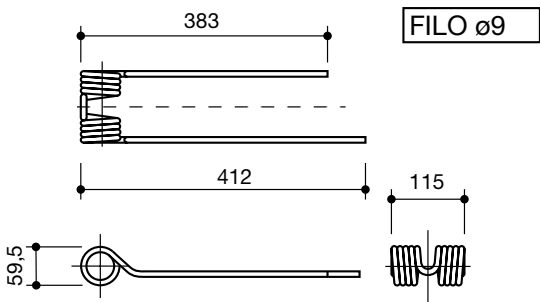
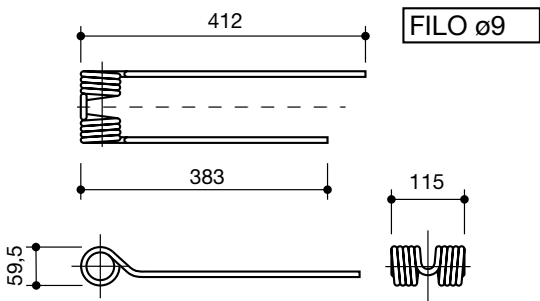
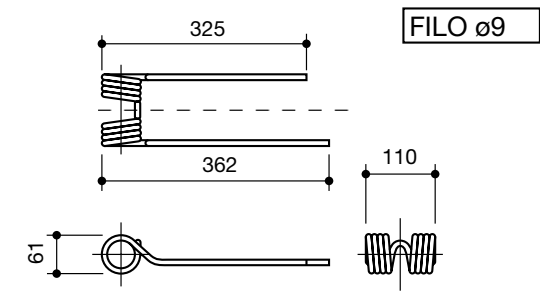
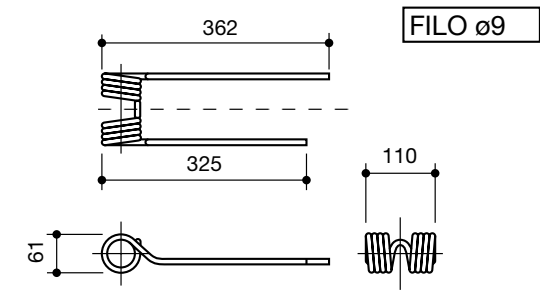
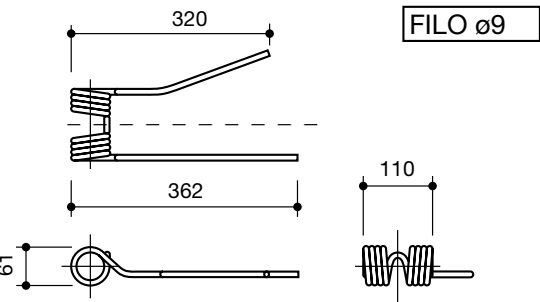
denti girello tines for rotary hay tedders	denominazione denomination	rif. la spirale	rif. originale
 <p>FILO $\varnothing 9$</p>	<p>PZ FANEX</p>	<p>LS40073</p>	<p>PZ272</p>
 <p>FILO $\varnothing 9$</p>	<p>PZ FANEX destro</p>	<p>LS40074</p>	<p>PZ339</p>
 <p>FILO $\varnothing 9$</p>	<p>PZ FANEX sinistro</p>	<p>LS40075</p>	<p>PZ340</p>
 <p>FILO $\varnothing 9$</p>	<p>PZ FLEVO</p>	<p>LS40076</p>	<p>PZ214</p>
 <p>FILO $\varnothing 9$</p>	<p>PZ FLEVO</p>	<p>LS40077</p>	<p>PZ215</p>
 <p>FILO $\varnothing 9$</p>	<p>PZ FLEVO</p>	<p>LS40078</p>	<p>PZ222</p>

denti girello
tines for rotary hay tedders

denominazione
denomination

rif.
la spirale

rif.
originale

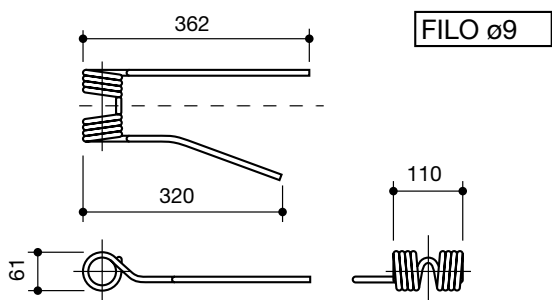

PZ
FLEVO

LS40079

PZ221

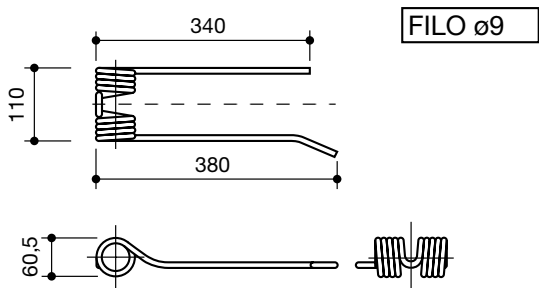

PZ
STRELA

LS40080

PZ106

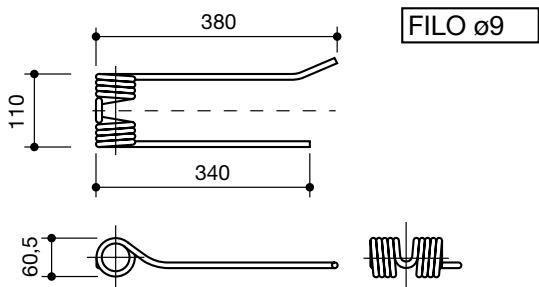

PZ
STRELA

LS40081

PZ107

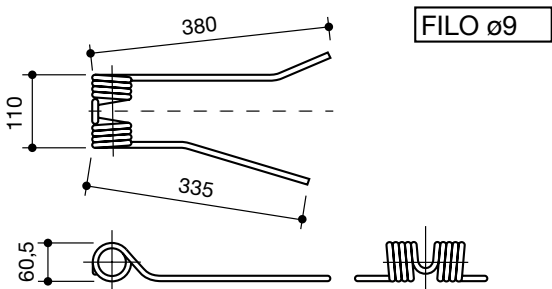

PZ
STRELA

LS40082

PZ110

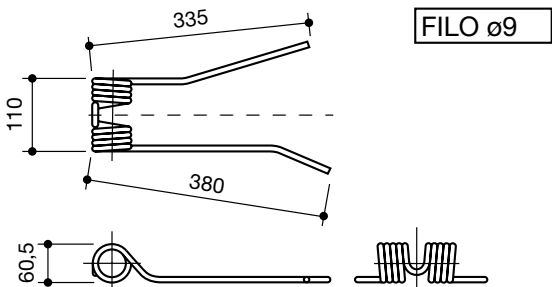

PZ
STRELA

LS40083

PZ111

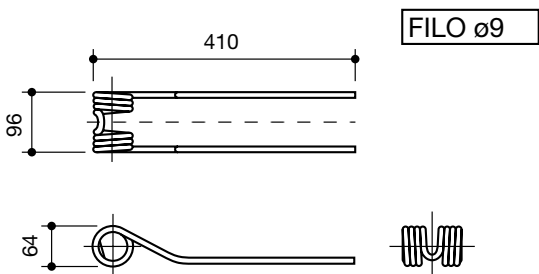

SLAM
1° tipo

LS40084

40

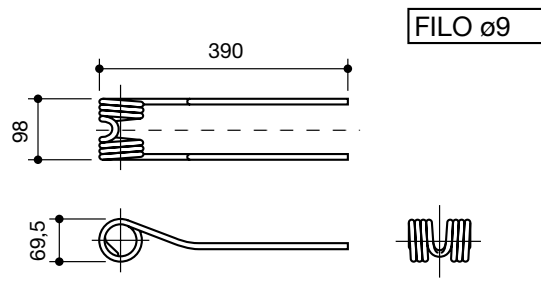
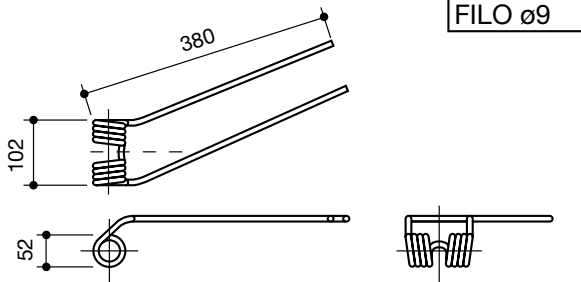
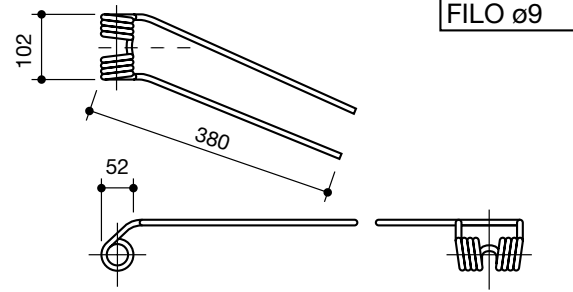
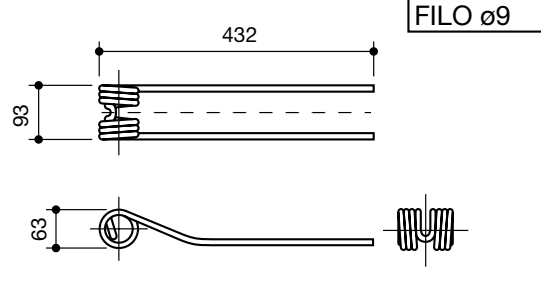
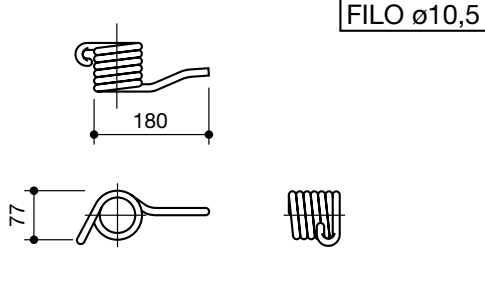
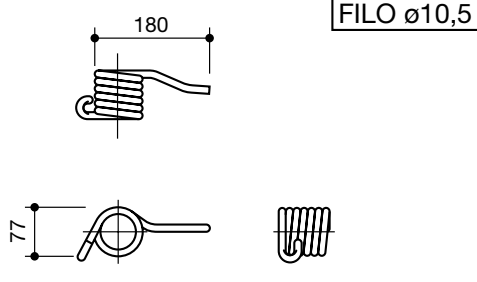
denti girello tines for rotary hay tedders	denominazione denomination	rif. la spirale	rif. originale
 <p>FILO $\varnothing 9$</p>	<p>SLAM 2° tipo</p>	<p>LS40085</p>	
 <p>FILO $\varnothing 9$</p>	<p>SUPERTINO destro</p>	<p>LS40086</p>	
 <p>FILO $\varnothing 9$</p>	<p>SUPERTINO sinistro</p>	<p>LS40087</p>	
 <p>FILO $\varnothing 9$</p>	<p>TIGRE</p>	<p>LS40088</p>	
 <p>FILO $\varnothing 10,5$</p>	<p>VICON CH300</p>	<p>LS40089</p>	<p>90036183</p>
 <p>FILO $\varnothing 10,5$</p>	<p>VICON CH300</p>	<p>LS40090</p>	<p>90036182</p>

denti girello
tines for rotary hay tedders

denominazione
denomination

rif.
la spirale

rif.
originale

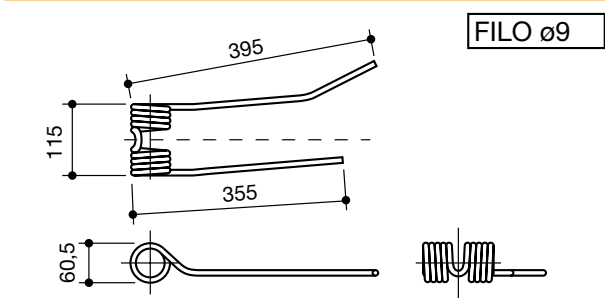

ZAGA

LS40091

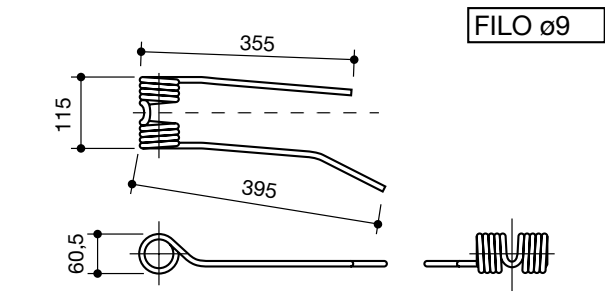

ZAGA

LS40092

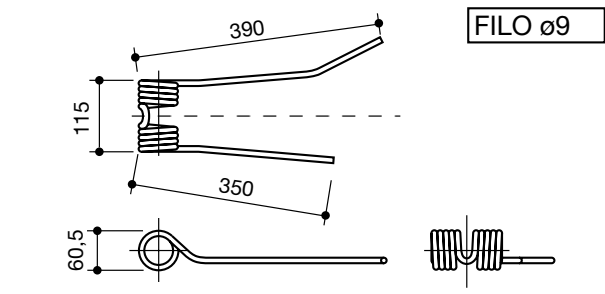

ZAGA

LS40093

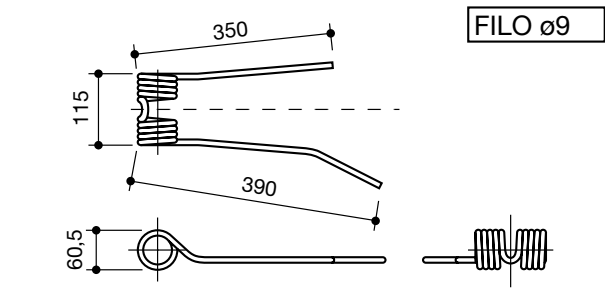

ZAGA

LS40094

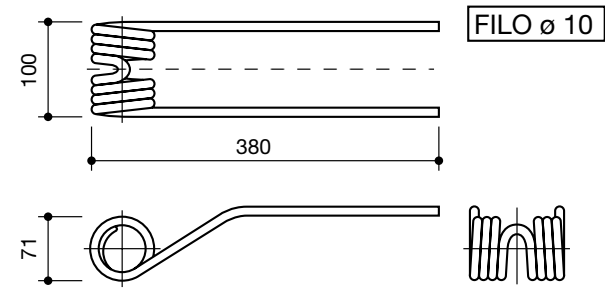

STOLL

LS40095

0635240

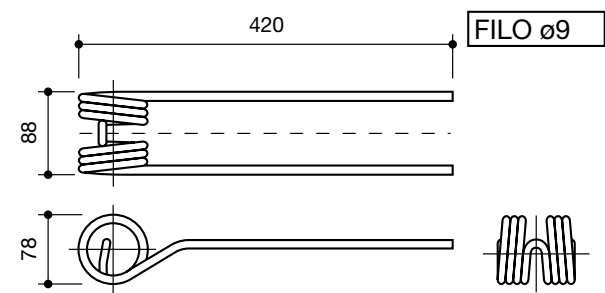

IMA

LS40096

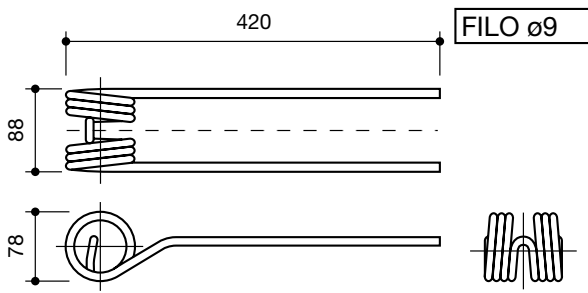
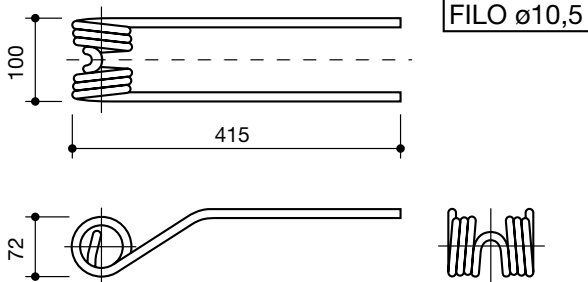
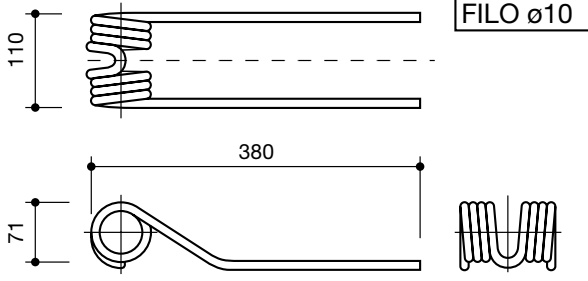
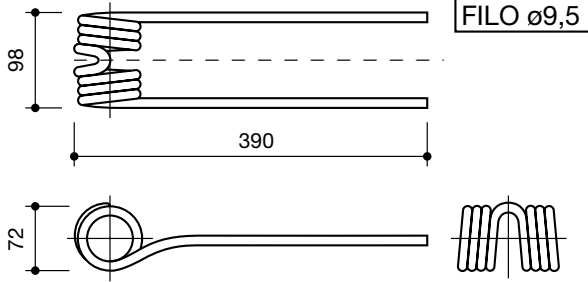
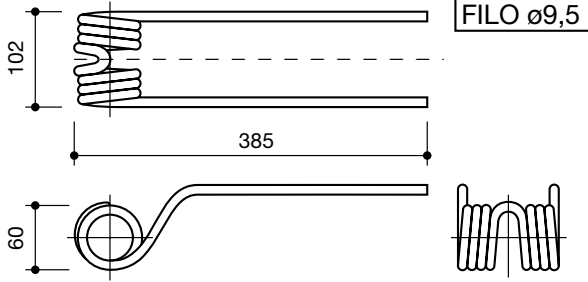
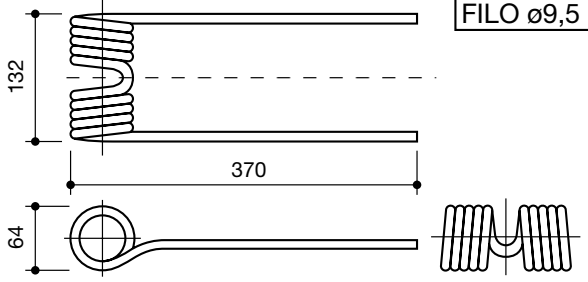
denti girello tines for rotary hay tedders	denominazione denomination	rif. la spirale	rif. originale
	DA ROS	LS40097	
	SIP	LS40098	153910405 264081
	FAHR filo 10	LS40099	16502744 0656-5574
	POTTINGER	LS40100	436145
	CLAAS	LS40101	902344.2
	CLAAS	LS40102	956815.1

denti girello
tines for rotary hay tedders

denominazione
denomination

rif.
la spirale

rif.
originale

	<p>FILO \varnothing 10</p>	<p>KRONE destro</p>	<p>LS40103</p>	<p>153014.1</p>
	<p>FILO \varnothing 10</p>	<p>KRONE sinistro</p>	<p>LS40104</p>	<p>153015.1</p>
	<p>FILO \varnothing 9,5</p>	<p>IMA 2° tipo</p>	<p>LS40105</p>	
	<p>FILO \varnothing 9</p>	<p>FAHR 5221</p>	<p>LS40106</p>	<p>1662005786</p>
	<p>FILO \varnothing 10</p>	<p>FAHR 5521</p>	<p>LS40107</p>	<p>1660756486</p>
	<p>FILO \varnothing 10</p>	<p>VICON</p>	<p>LS40108</p>	

40

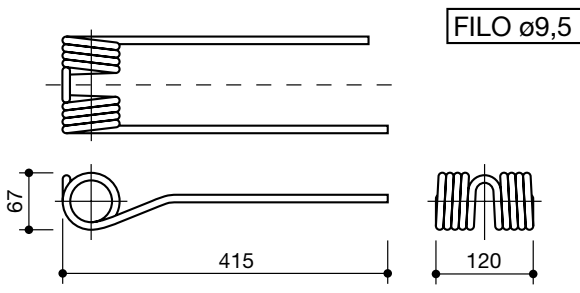
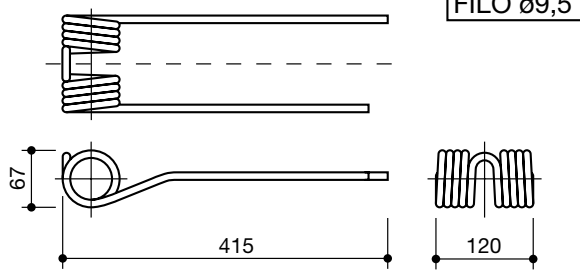
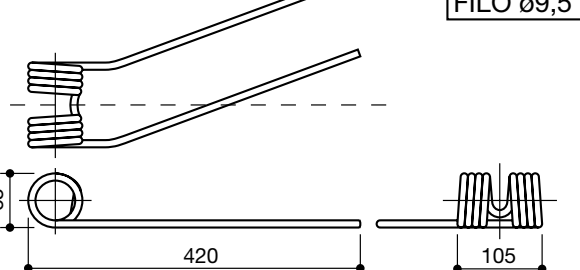
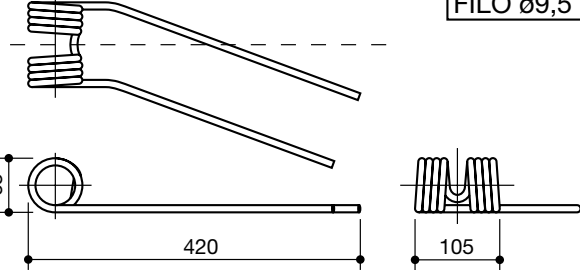
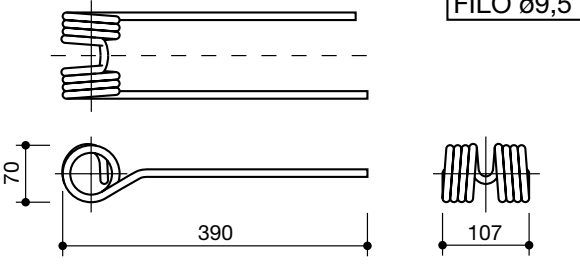
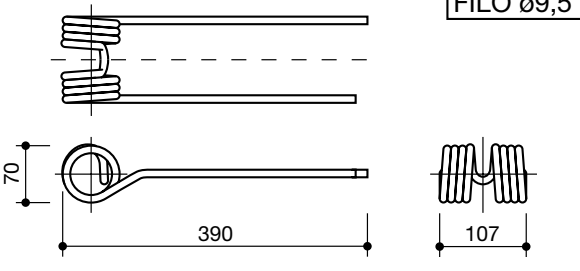
denti girello tines for rotary hay tedders	denominazione denomination	rif. la spirale	rif. originale
 <p>Technical drawing of the SIP destro tine. It shows a side view and a top view. The side view shows a curved tine with a length of 415 mm and a diameter of 67 mm. The top view shows a spiral with a width of 120 mm. A label indicates the wire diameter is FILO ø9,5.</p>	<p>SIP destro</p>	<p>LS40109</p>	
 <p>Technical drawing of the SIP sinistro tine. It shows a side view and a top view. The side view shows a curved tine with a length of 415 mm and a diameter of 67 mm. The top view shows a spiral with a width of 120 mm. A label indicates the wire diameter is FILO ø9,5.</p>	<p>SIP sinistro</p>	<p>LS40110</p>	
 <p>Technical drawing of the FCR destro tine. It shows a side view and a top view. The side view shows a curved tine with a length of 420 mm and a diameter of 65 mm. The top view shows a spiral with a width of 105 mm. A label indicates the wire diameter is FILO ø9,5.</p>	<p>FCR destro</p>	<p>LS40111</p>	
 <p>Technical drawing of the FCR sinistro tine. It shows a side view and a top view. The side view shows a curved tine with a length of 420 mm and a diameter of 65 mm. The top view shows a spiral with a width of 105 mm. A label indicates the wire diameter is FILO ø9,5.</p>	<p>FCR sinistro</p>	<p>LS40112</p>	
 <p>Technical drawing of the KUHN tine. It shows a side view and a top view. The side view shows a curved tine with a length of 390 mm and a diameter of 70 mm. The top view shows a spiral with a width of 107 mm. A label indicates the wire diameter is FILO ø9,5.</p>	<p>KUHN</p>	<p>LS40113</p>	<p>58740700</p>
 <p>Technical drawing of the KUHN tine. It shows a side view and a top view. The side view shows a curved tine with a length of 390 mm and a diameter of 70 mm. The top view shows a spiral with a width of 107 mm. A label indicates the wire diameter is FILO ø9,5.</p>	<p>KUHN</p>	<p>LS40114</p>	<p>587406</p>

denti girello
tines for rotary hay tedders

denominazione
denomination

rif.
la spirale

rif.
originale

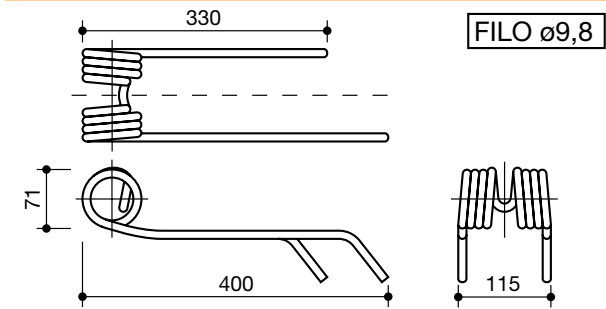

GALFRÈ
destro

LS40115

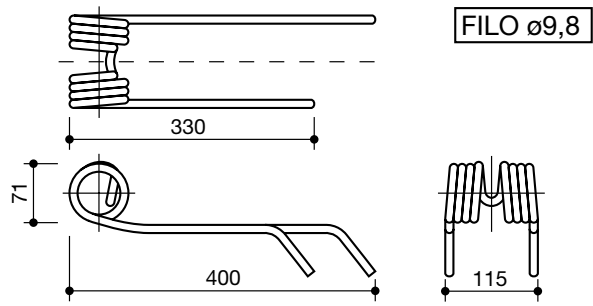

GALFRÈ
sinistro

LS40116

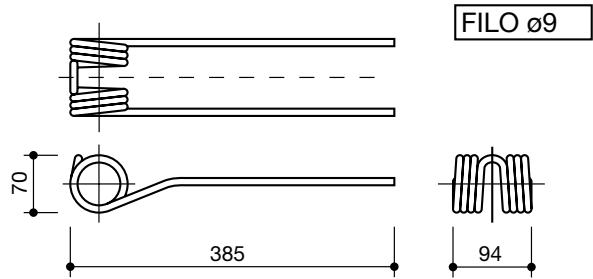

FELLA

LS40117

150296

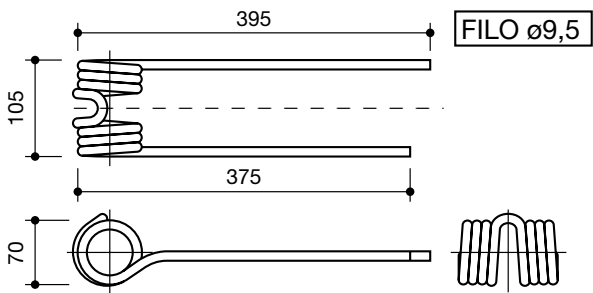

POTTINGER
sinistro

LS40118

436150

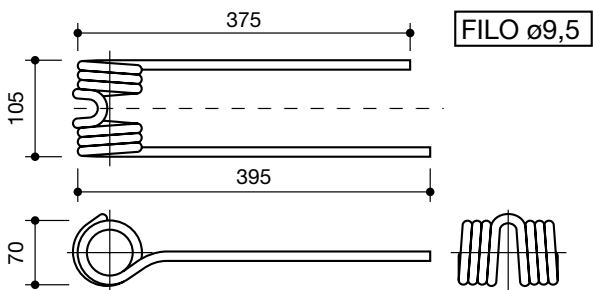

POTTINGER
destro

LS40119

436149

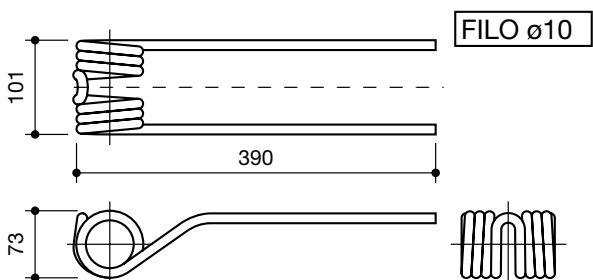

DA ROS

LS40120

40

denti girello
tines for rotary hay tedders

denominazione
denomination

ref.
la spirale

ref.
originale

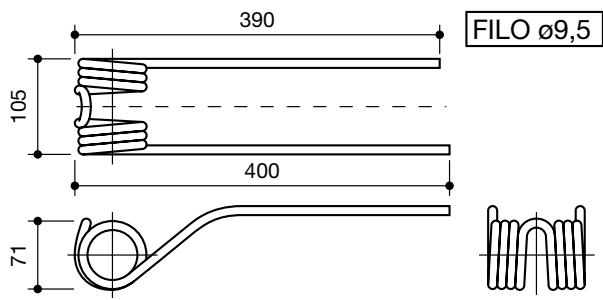

STOLL
destro

LS40121

0673743

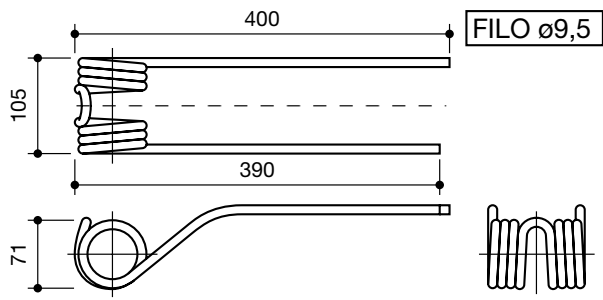

STOLL
sinistro

LS40122

0673744

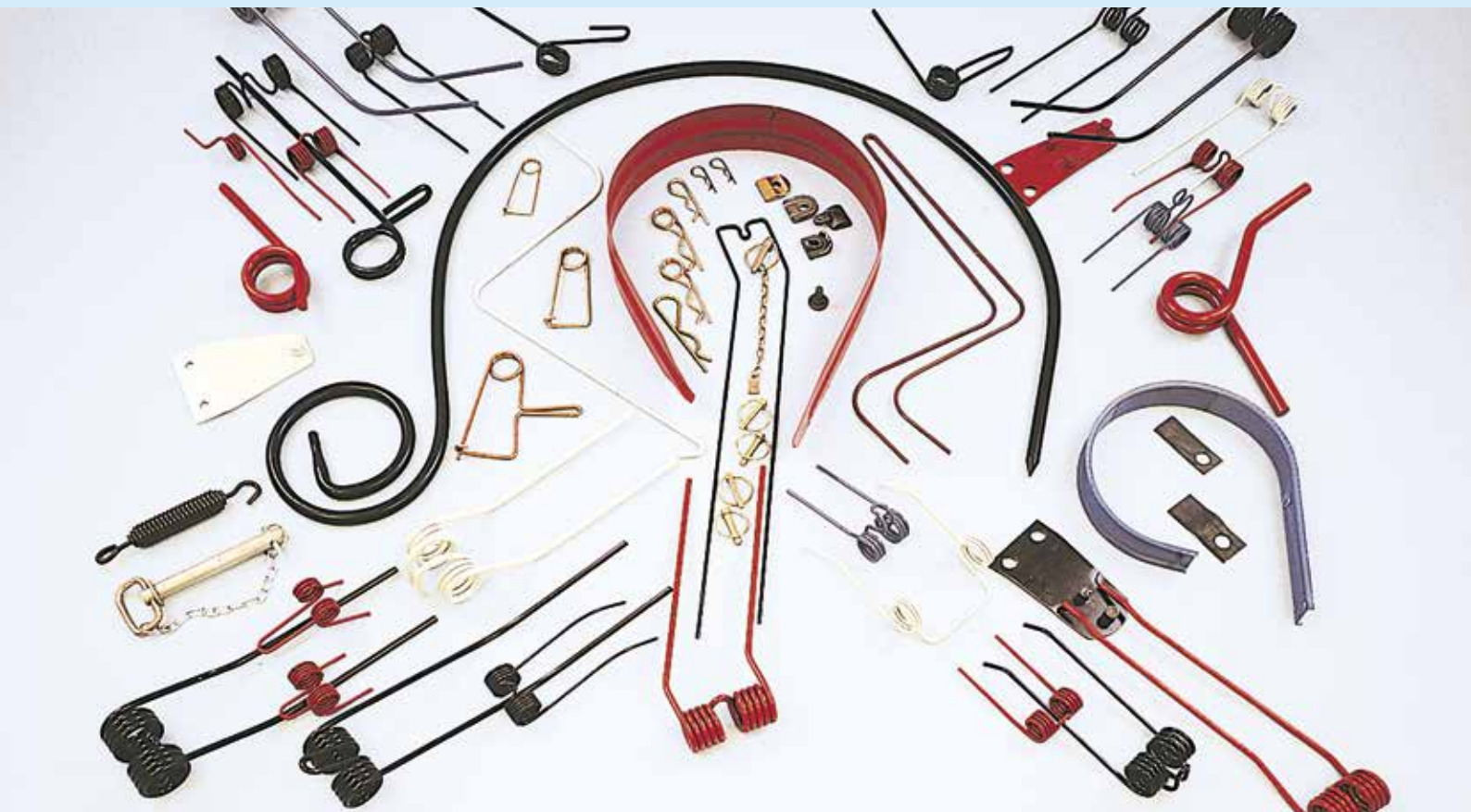

LA SPIRALE srl
via Milano, 8 - 20084 Lacchiarella (MI) - ITALY
tel. +39 02 90076666 +39 02 9008095
fax +39 02 9007338
www.laspiralemolle.it - e-mail: laspirale@tin.it