

# Attacchi fermadente e molle varie

Tine holders and assorted springs

Fixations et ressorts

Zinken befestigungen und federn

Piezas de sujecion y muelles

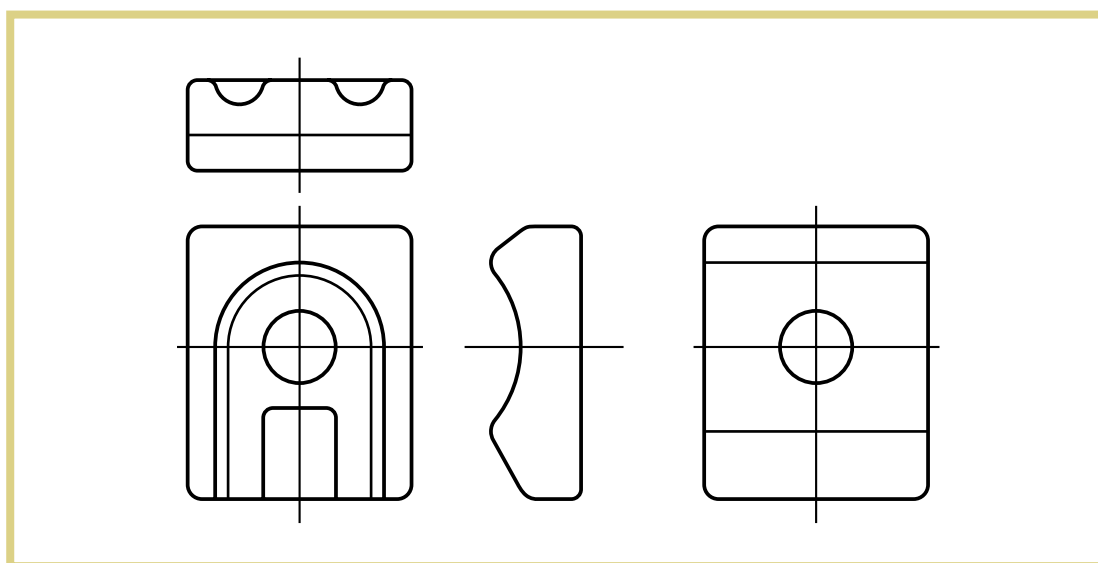

attacchi fermadente e molle varie  
tine holders and assorted springs

denominazione  
denomination

rif.  
la spirale

rif.  
originale

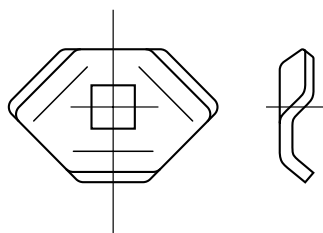

PRESSA  
**JOHN BALLER**

LS99001

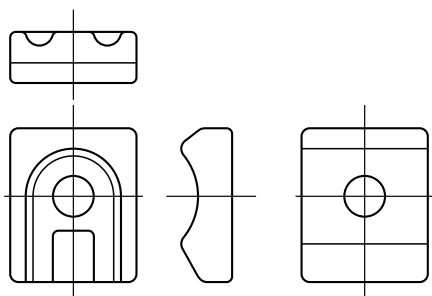

ANDANATORE  
**KUHN**

LS99002

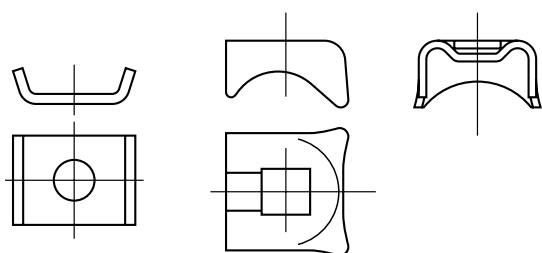

DECHENTRAITER

LS99003

42272.3

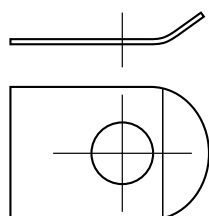

RANGHINATORE  
**CORMICK**

LS99004

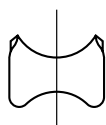
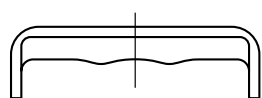
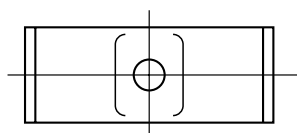

AUTOCARICANTE  
**BERNI**  
EUROPA

LS99005

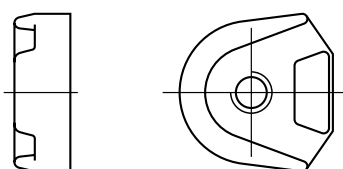

AUTOCARICANTE  
**MENGELE**

LS99006

04035692

**attacchi fermadente e molle varie**  
tine holders and assorted springs

**denominazione**  
denomination

**rif.**  
**la spirale**

**rif.**  
**originale**

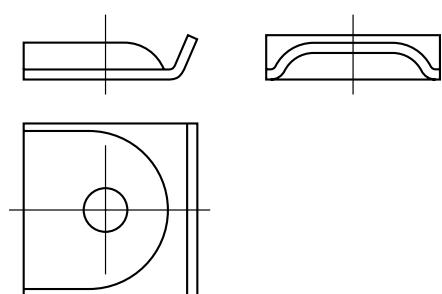

RANGHINATORE  
**REPOSSI**

**LS99007**

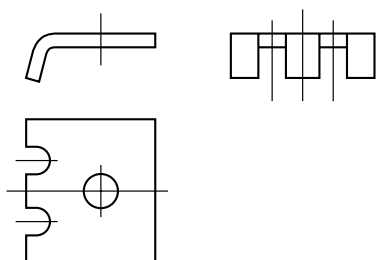

RANGHINATORE  
**FORT**  
F2

**LS99008**

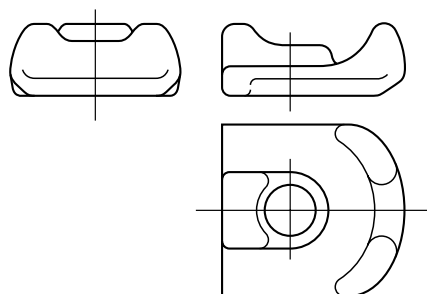

**GIRELLO**  
INFERIORE

**LS99009**

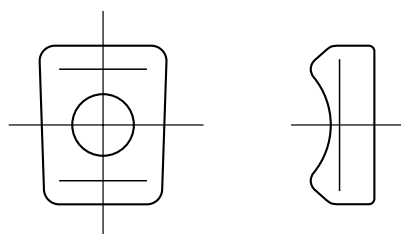

**GIRELLO**  
SUPERIORE

**LS99010**

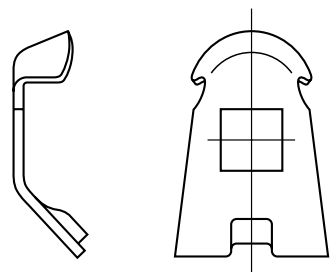

VOLTAFIENO  
**LINCE**

**LS99011**

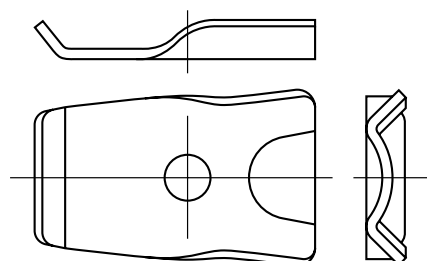

RANGHINATORE  
**ORIONE**

**LS99012**

**294036A**

attacchi fermadente e molle varie  
tine holders and assorted springs

denominazione  
denomination

rif.  
la spirale

rif.  
originale

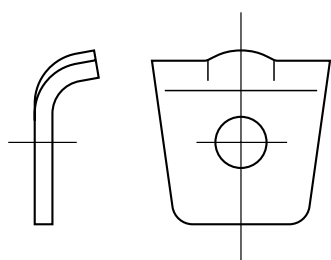

AUTOCARICANTE  
**KRONE**

LS99013

242004

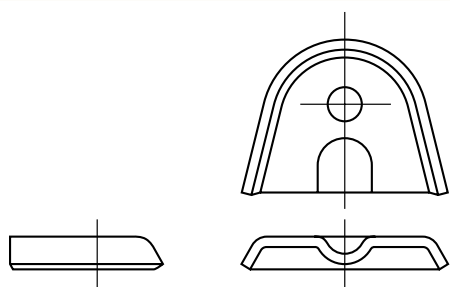

RANGHINATORE  
**HEUMA**

LS99014

001141

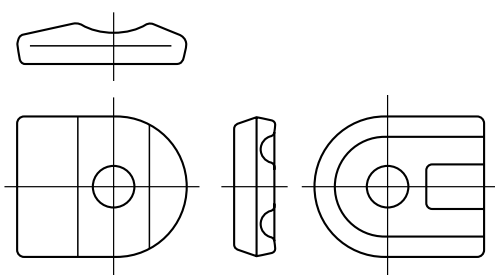

ANDANATORE  
**UNIVERSALE**

LS99015

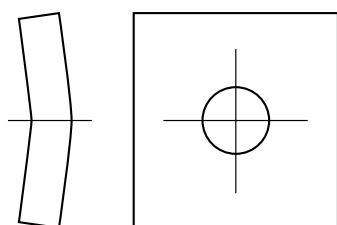

GIRELLO  
**SLAM  
FONTANESI**

LS99016

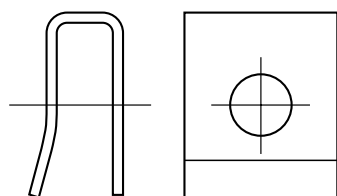

ANDANATORE  
**STOLL**

LS99017

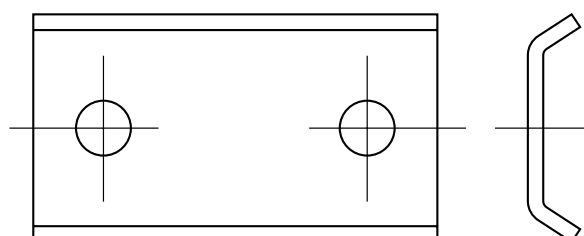

SEMINATRICE  
**CARRARO  
NODET**

LS99018

**attacchi fermadente e molle varie**  
tine holders and assorted springs

**denominazione**  
denomination

**rif.**  
**la spirale**

**rif.**  
**originale**

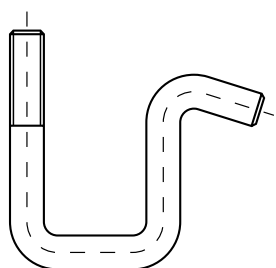

**STRIGLIATORE**  
**VIBROCULT**  
30 x 30

**LS99019**

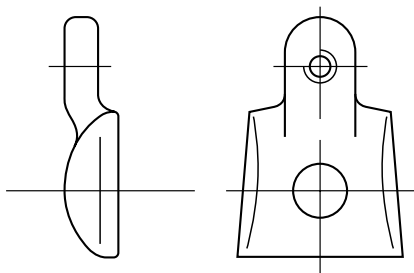

**GIRELLO**  
**FAHR**

**LS99020**

**06565650**

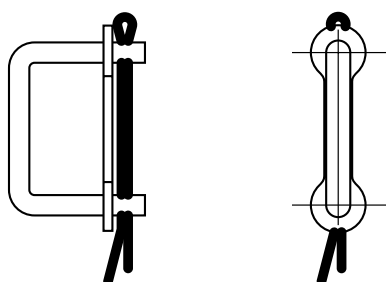

**GIUNTO CATENA**  
in filo

**LS99021**

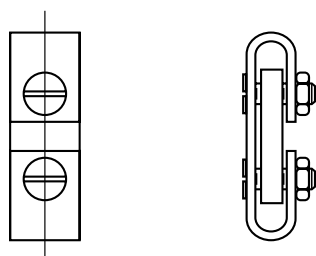

**GIUNTO CATENA**  
in piatto

**LS99022**

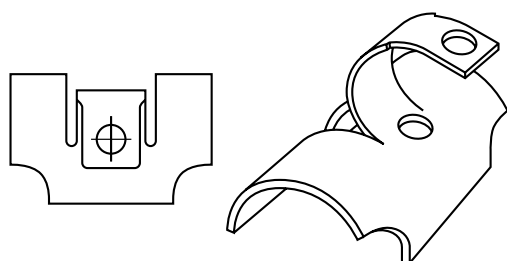

**PRESSA**  
**WELGER**

**LS99023**

**0338300000**

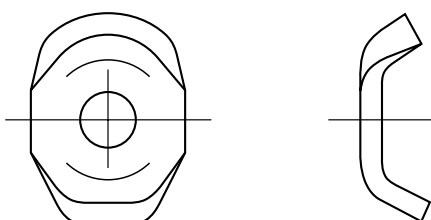

**ANDANATORE**  
**GALFRÈ**

**LS99024**

attacchi fermadente e molle varie  
tine holders and assorted springs

denominazione  
denomination

rif.  
la spirale

rif.  
originale

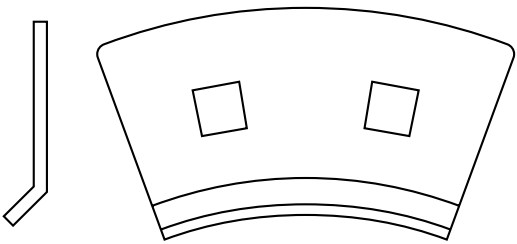
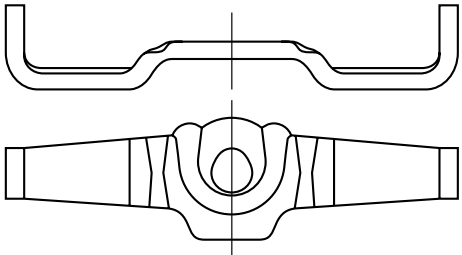
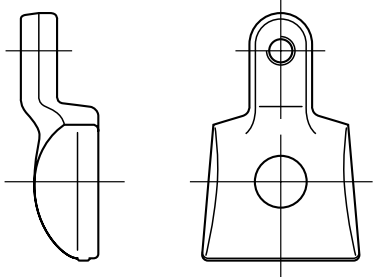
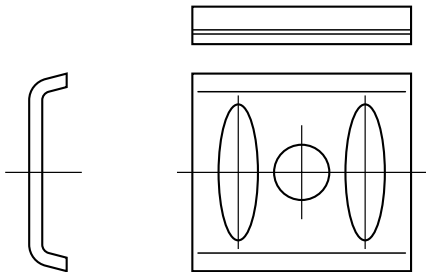
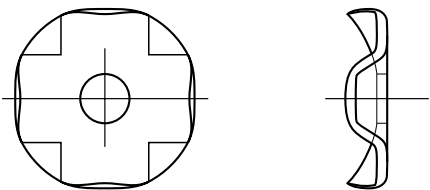
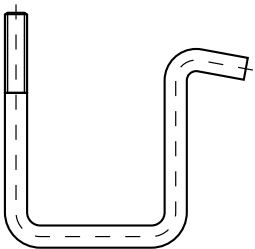
	<p>RANGHINATORE <b>VICON</b></p>	<p>LS99025</p>	
	<p>GIRELLO <b>PZ FANEX</b></p>	<p>LS99026</p>	<p>GZ280V</p>
	<p>GIRELLO <b>FAHR MORRA</b></p>	<p>LS99027</p>	<p>FAHR 06565744 MORRA 010834</p>
	<p>PIASTRINA FISSAGGIO <b>MORRA</b></p>	<p>LS99028</p>	<p>06103038292</p>
	<p>RONDELLA FISSAGGIO <b>VIBROCULT</b></p>	<p>LS99029</p>	
	<p>STRIGLIATORE <b>VIBROCULT</b> 50 x 50</p>	<p>LS99030</p>	

**attacchi fermadente e molle varie**  
tine holders and assorted springs

**denominazione**  
denomination

**rif.**  
**la spirale**

**rif.**  
**originale**



**GIRELLO  
FELLA**

**LS99031**

**477399  
150094  
487380**

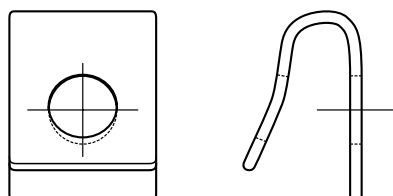

**ANDANATORE  
CLAAS**

**LS99032**

**953643**

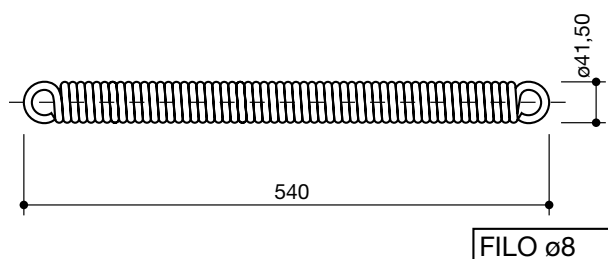

MOLLA  
TRAZIONE  
ROTATIVA  
**PZ**

LS99301

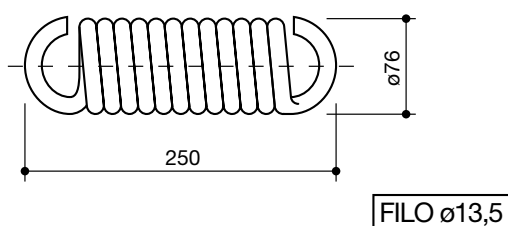

MOLLA  
TRAZIONE  
ROTOPRESSA  
**KRONE**

LS99302

9396291

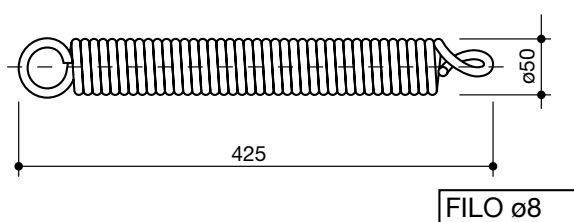

MOLLA  
TRAZIONE  
ROTATIVA  
**FORT**

LS99303

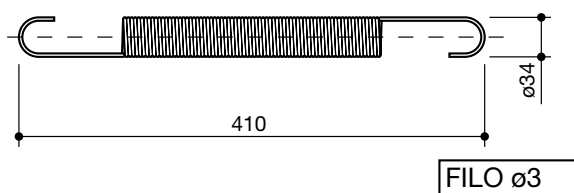

MOLLA  
PARALLELE  
**FIAT**

LS99304

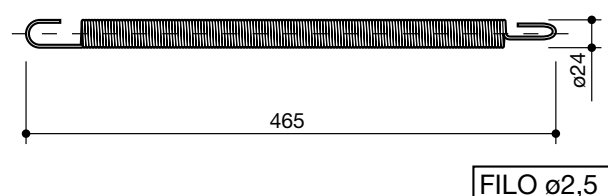

MOLLA  
PARALLELE  
**DEUTZ**

LS99305

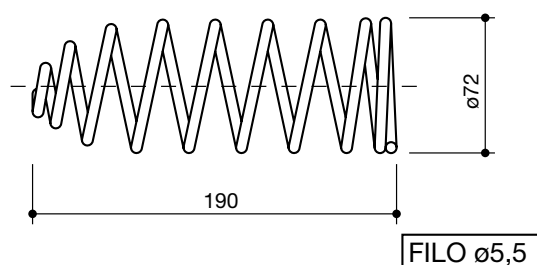

MOLLA  
BRACCIO  
SINISTRO  
**BCS**

LS99306

20137



**attacchi fermadente e molle varie**  
tine holders and assorted springs

**denominazione**  
denomination

**rif.**  
**la spirale**

**rif.**  
**originale**

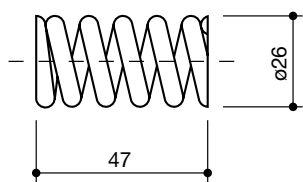

FILO  $\varnothing 5,5$

MOLLA  
BIELLA  
**BCS**

**LS99307**

**58002430**

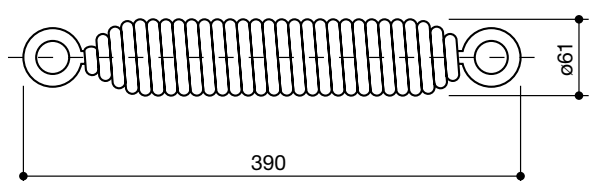

FILO  $\varnothing 10$

MOLLA  
ARATRO  
**MORO**  
10

**LS99308**

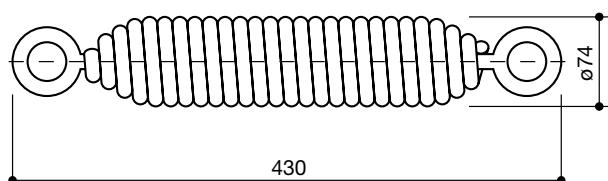

FILO  $\varnothing 12$

MOLLA  
ARATRO  
**ERMO**  
12

**LS99309**

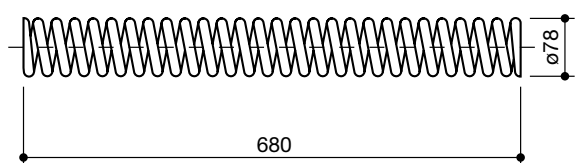

FILO  $\varnothing 13$

MOLLA  
**BREGA**  
13

**LS99312**

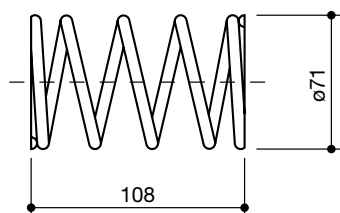

FILO  $\varnothing 6$

MOLLA  
FRIZIONE  
**BCS**

**LS99313**

**58002306**

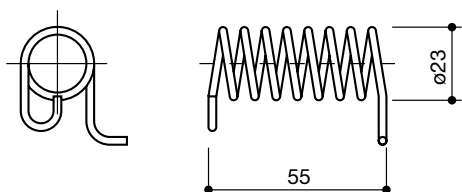

FILO  $\varnothing 2,5$

MOLLA  
TORSIONE  
**PZ**  
099

**LS99314**

**PZ099**

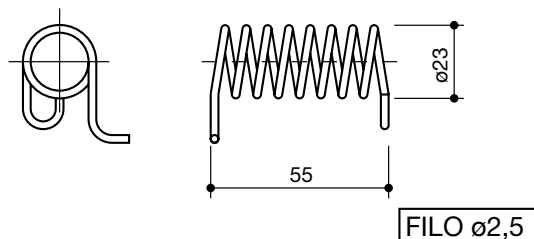

MOLLA  
TORSIONE  
**PZ**  
100

LS99315

PZ100

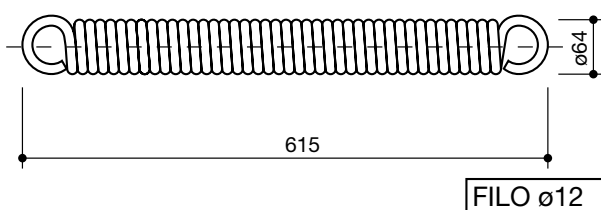

MOLLA  
TRAZIONE  
ROTATIVA  
**GALFRÈ**

LS99316

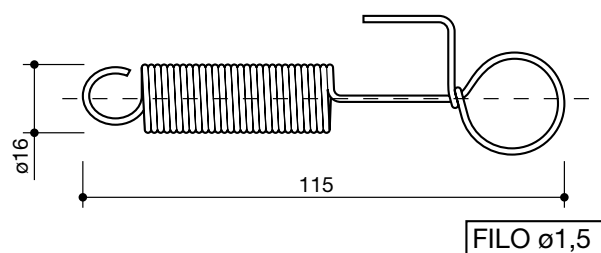

MOLLA  
PROTEZIONE  
**PARALAMA**

LS99317

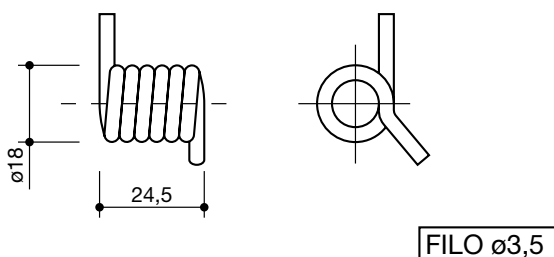

MOLLA  
FERMADENTE  
GIRELLO  
**LELY**

LS99318

4101500540

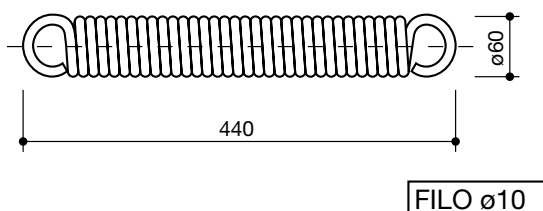

MOLLA  
SPAZZANEVE

LS99319

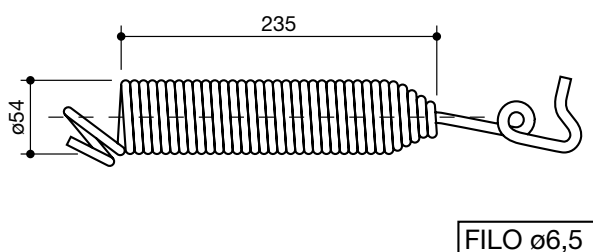

MOLLA  
TRAZIONE  
**TONUTTI**

LS99320

RC40AZ019

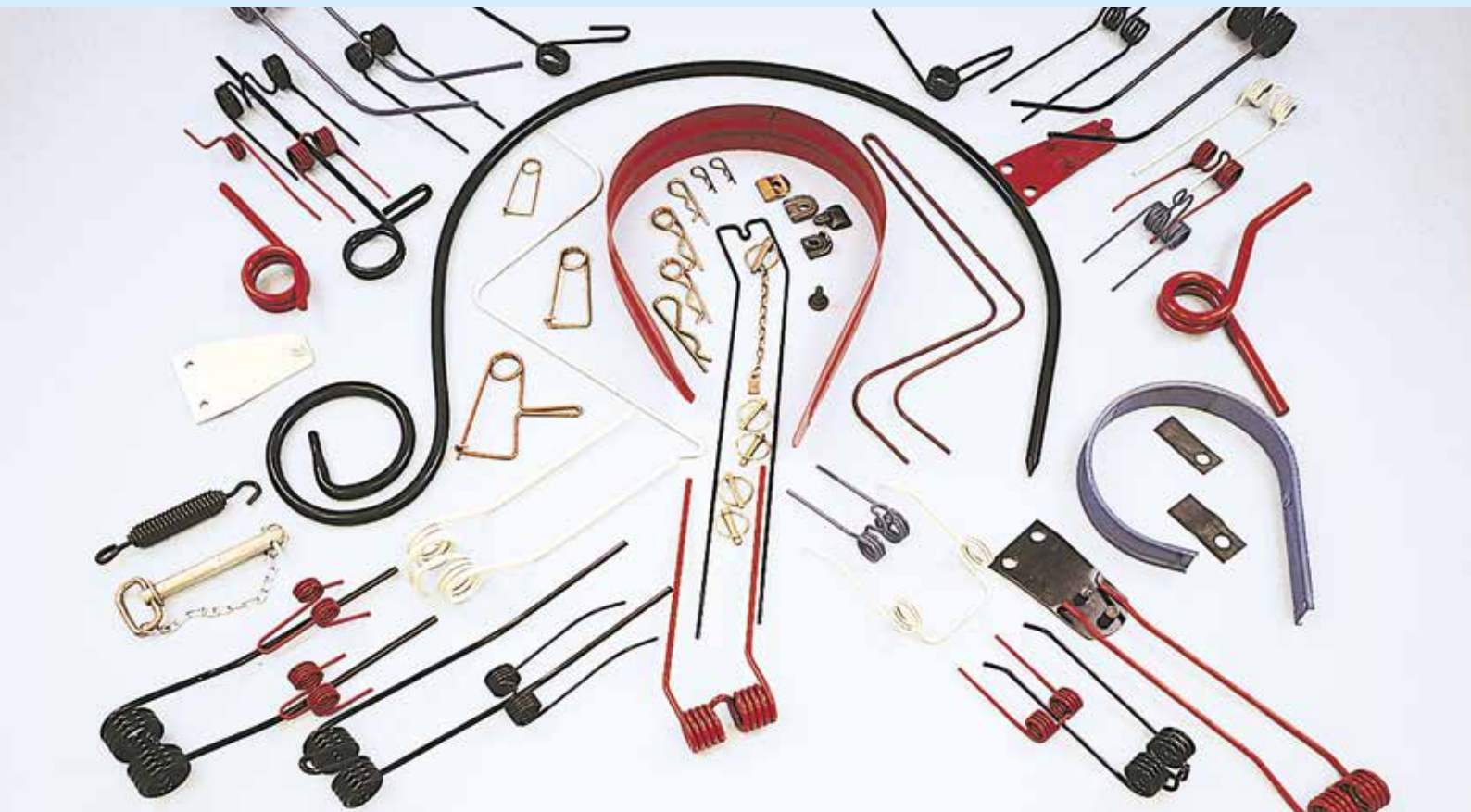

**LA SPIRALE** srl  
via Milano, 8 - 20084 Lacchiarella (MI) - ITALY  
tel. +39 02 90076666 +39 02 9008095  
fax +39 02 9007338  
[www.laspiralemolle.it](http://www.laspiralemolle.it) - e-mail: [laspirale@tin.it](mailto:laspirale@tin.it)