

Denti giroandatore

Tines for windrowers

Dents pour andaineuses

Federzinken für heuschwader

Muelles para hileradoras

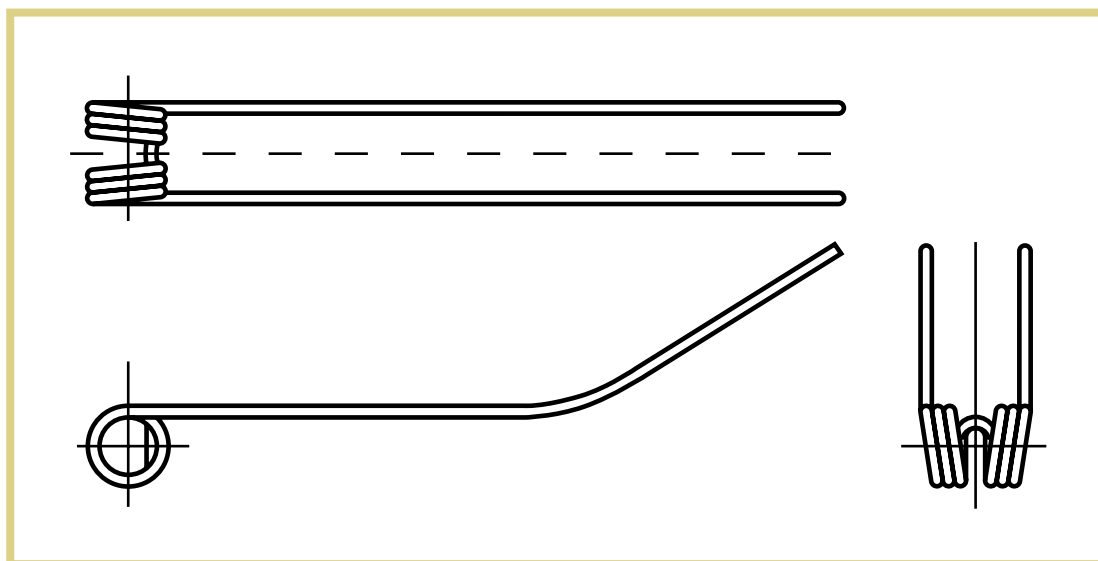

denti giroandatore
tines for windrowers

denominazione
denomination

rif.
la spirale

rif.
originale

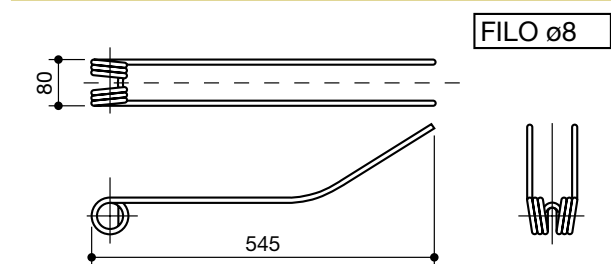

AIMETTA
1° tipo

LS30001

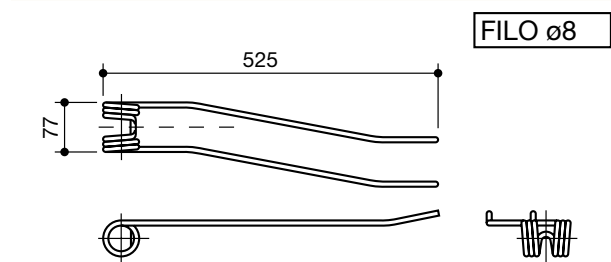

AIMETTA
2° tipo

LS30002

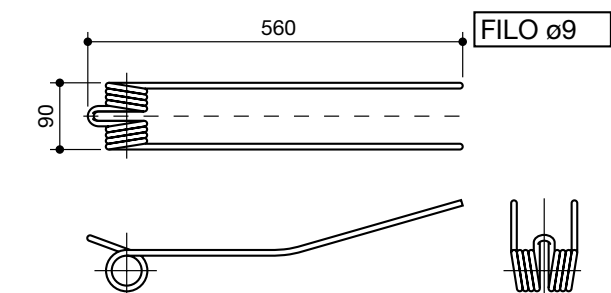

BCS
1° tipo

LS30003

8029

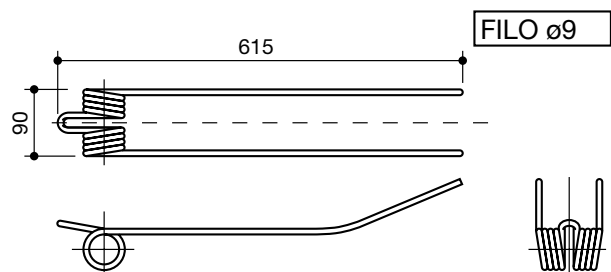

BCS
2° tipo

LS30004

8029.1

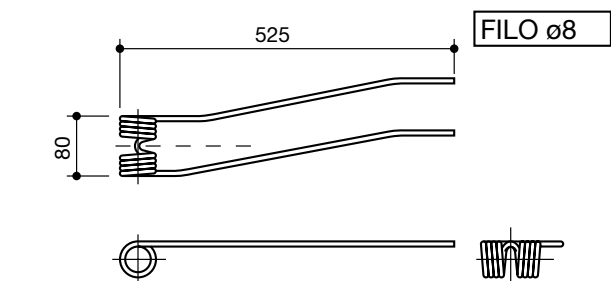

BORELLO
corto

LS30005

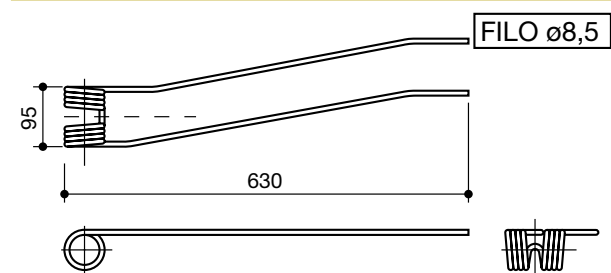

BORELLO
lungo destro

LS30006

denti giroandatore
tines for windrowers

denominazione
denomination

rif.
la spirale

rif.
originale

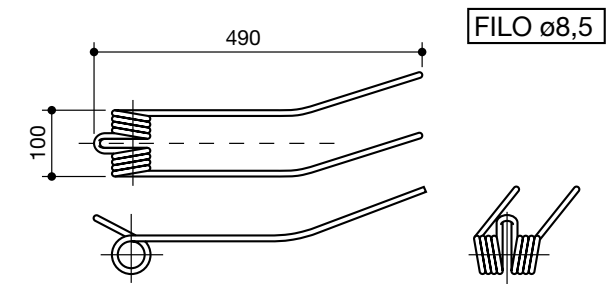

BORELLO
GIRORAMI

LS30007

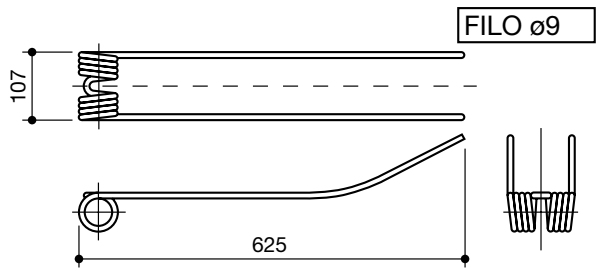

CECCATO

LS30008

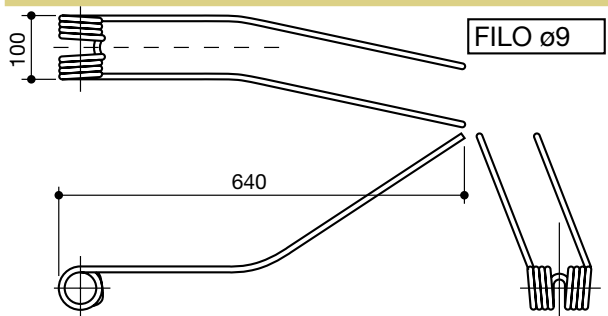

CIMAC

LS30009

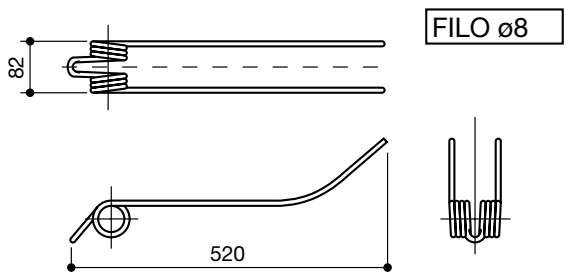

CLAAS
1° tipo

LS30010

9020830

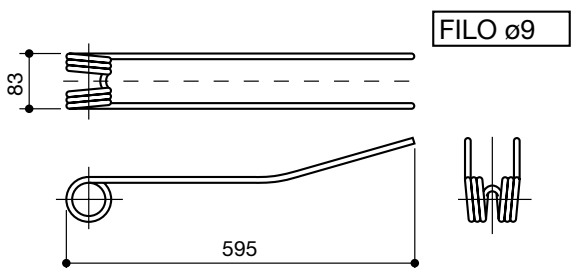

CLAAS
2° tipo

LS30011

902916
9554830 lungo

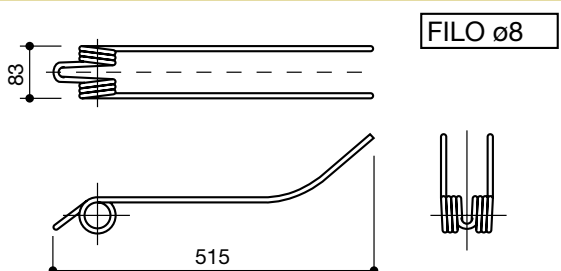

FAHR

LS30012

11036630113

denti giroandatore
tines for windrowers

denominazione
denomination

rif.
la spirale

rif.
originale

	<p>FAHR</p>	<p>LS30013</p>	<p>1108903010100 06231509</p>
	<p>FAHR</p>	<p>LS30014</p>	<p>16504331</p>
	<p>FELLA</p>	<p>LS30015</p>	<p>497032 492816 160313</p>
	<p>FELLA</p>	<p>LS30016</p>	<p>490471</p>
	<p>FIORINI destro</p>	<p>LS30017</p>	
	<p>FIORINI sinistro</p>	<p>LS30018</p>	

denti giroandatore
tines for windrowers

denominazione
denomination

rif.
la spirale

rif.
originale

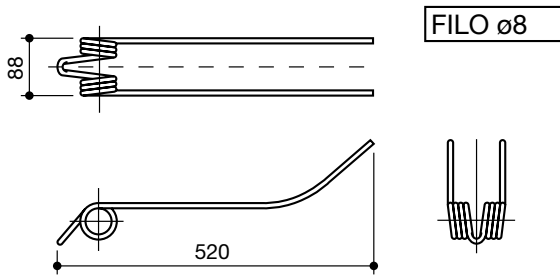

FONTANESI
1° tipo

LS30019

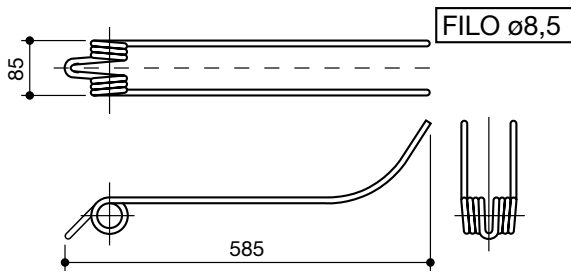

FONTANESI
2° tipo

LS30020

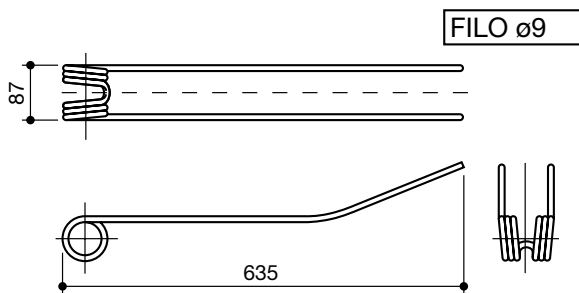

FORT
1° tipo

LS30021

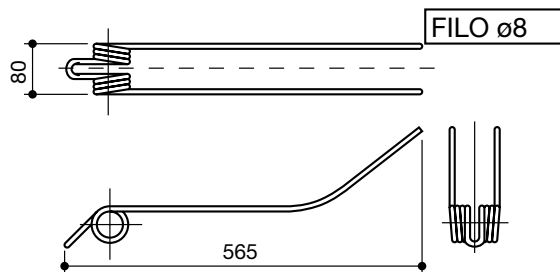

FORT
2° tipo

LS30022

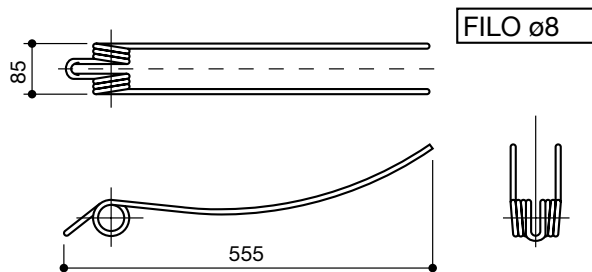

FORT
3° tipo

LS30023

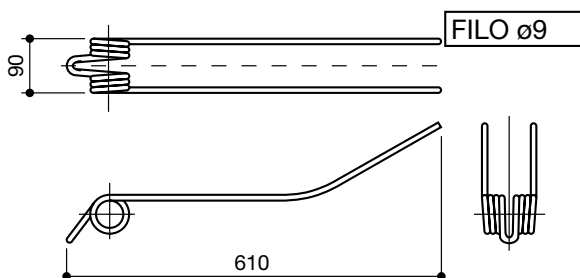

FORT
4° tipo

LS30024

denti giroandatore
tines for windrowers

denominazione
denomination

rif.
la spirale

rif.
originale

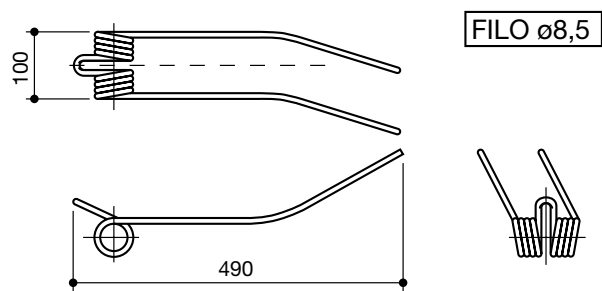

GALFRÈ
sinistro

LS30025

30AN

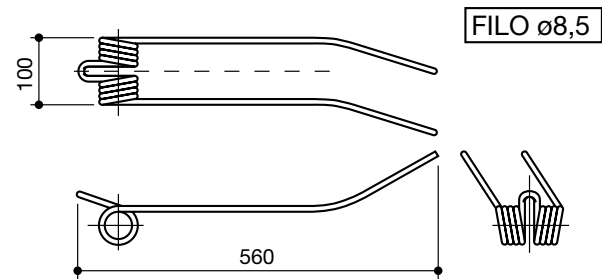

GALFRÈ
medio

LS30026

30AN1

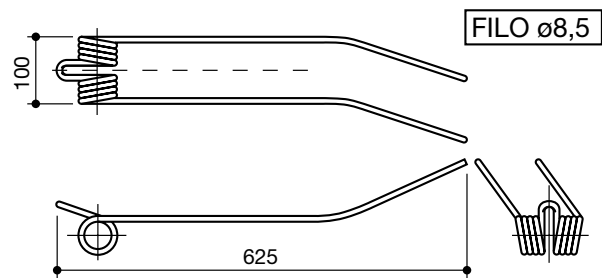

GALFRÈ
lungo

LS30027

30AN2

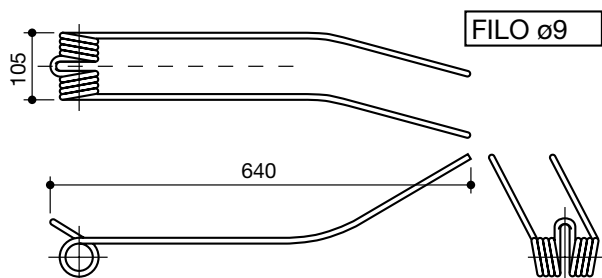

GALFRÈ
lunghissimo

LS30028

30AN3

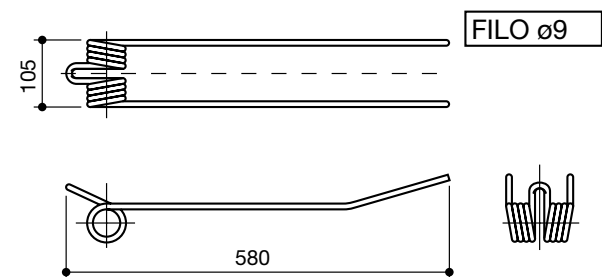

GALFRÈ
diritto

LS30029

30AN4

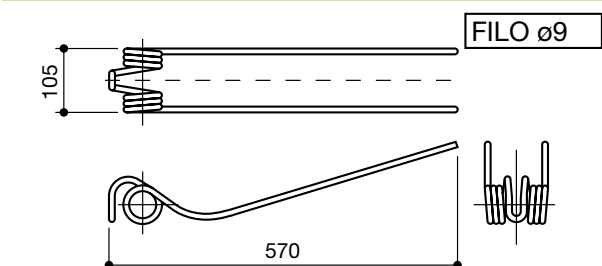

GALFRÈ
87

LS30030

78/87

denti giroandatore
tines for windrowers

denominazione
denomination

rif.
la spirale

rif.
originale

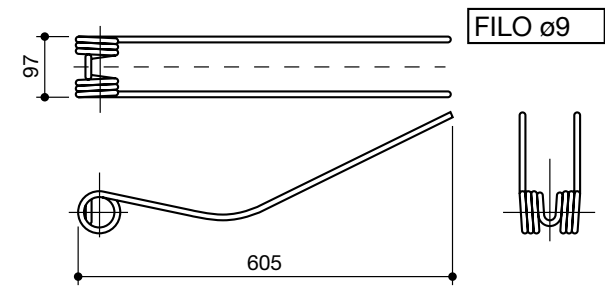

GALFRÈ
88

LS30031

78/88

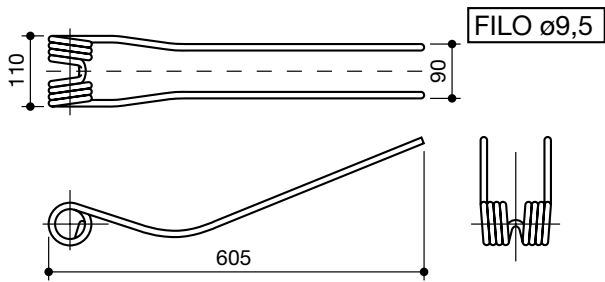

GALFRÈ
92

LS30032

78/92

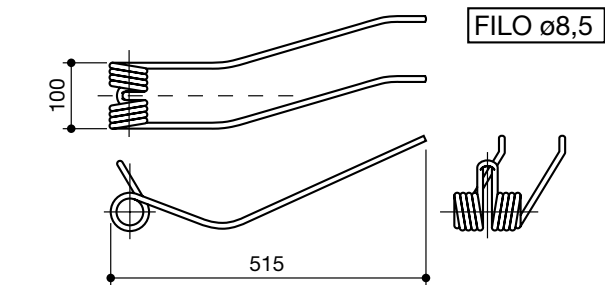

KUHN
GA200-230-250

LS30033

577017

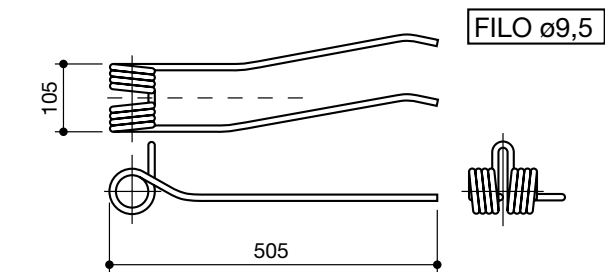

KUHN
GRS25

LS30034

5764401

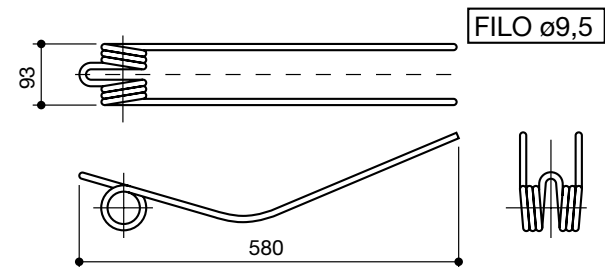

KUHN
GA381

LS30035

577202

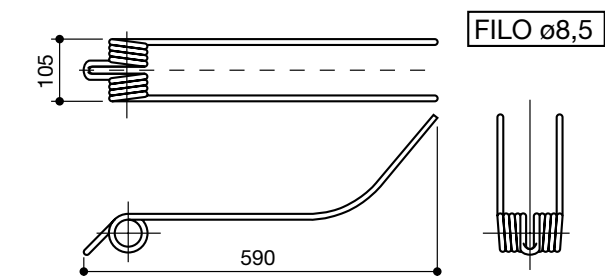

IMA
1° tipo

LS30036

denti giroandatore
tines for windrowers

denominazione
denomination

rif.
la spirale

rif.
originale

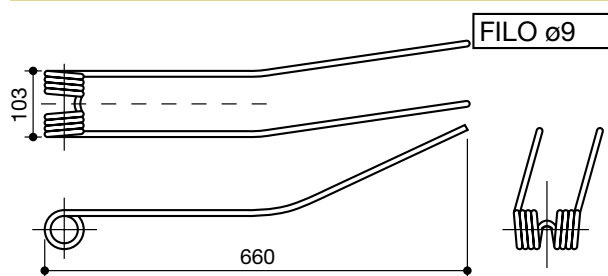

IMA
2° tipo

LS30037

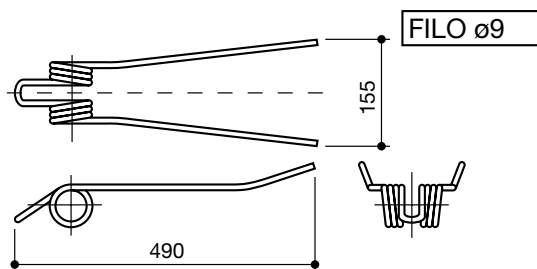

LELY

LS30038

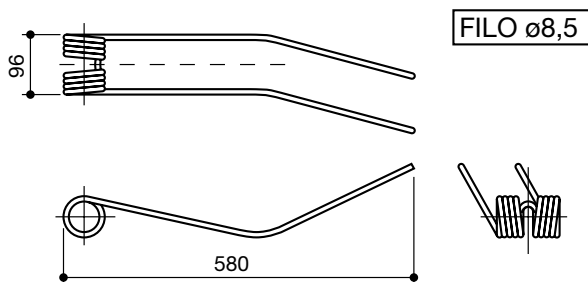

LINCE

LS30039

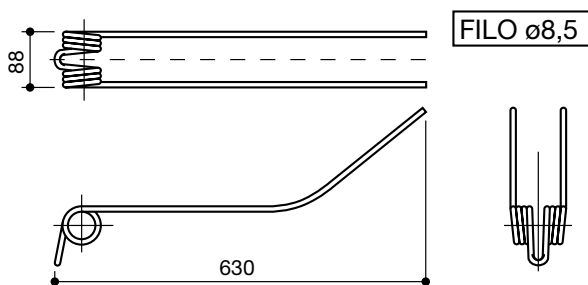

MOLON

LS30040

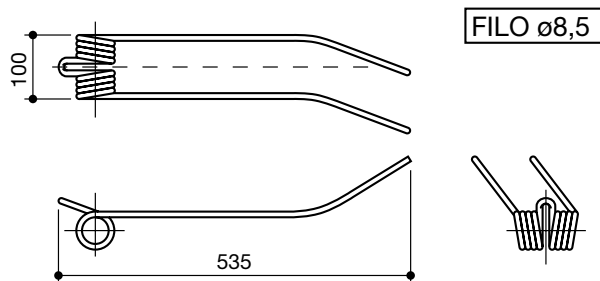

MORRA
1° tipo

LS30041

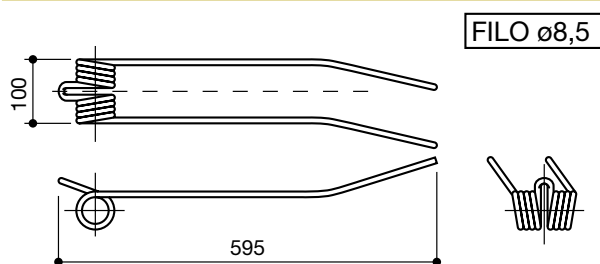

MORRA
2° tipo

LS30042

denti giroandatore
tines for windrowers

denominazione
denomination

rif.
la spirale

rif.
originale

FILO ø8

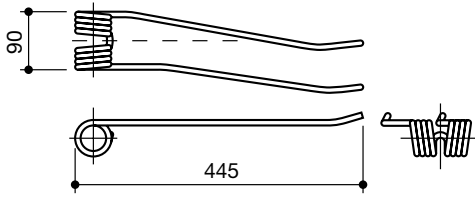

NEW HOLLAND

LS30043

FILO ø9

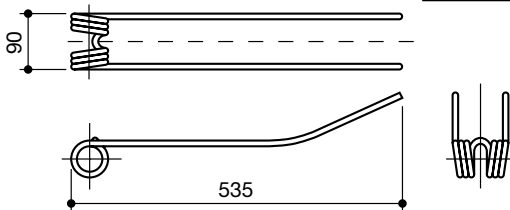

NIEMEYER

LS30044

12100

FILO ø9

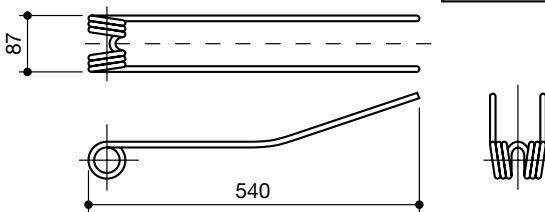

NIEMEYER
KW400

LS30045

12185

FILO ø9

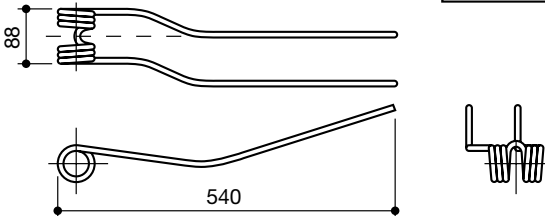

NIEMEYER

LS30046

600030

FILO ø8,5

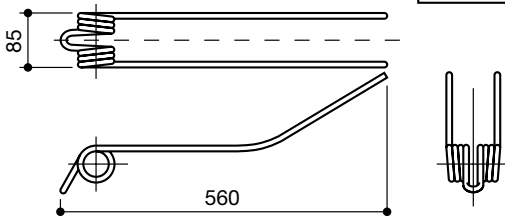

OLIVI

LS30047

FILO ø8,5

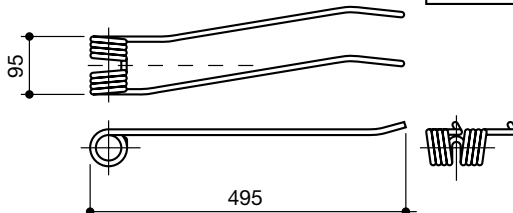

POTTINGER

LS30048

436007

denti giroandatore
tines for windrowers

denominazione
denomination

rif.
la spirale

rif.
originale

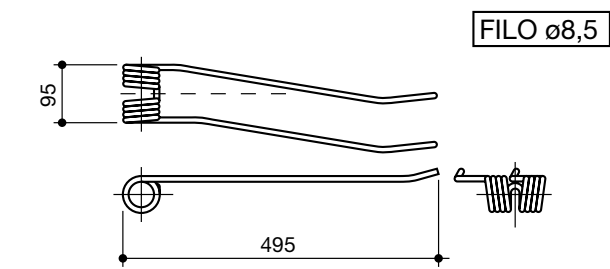

POTTINGER

LS30049

436006

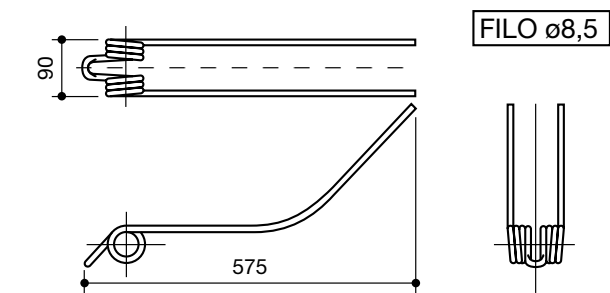

REPOSSI
1° tipo

LS30050

TR61

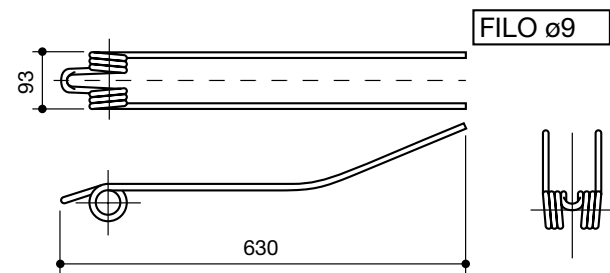

REPOSSI
2° tipo

LS30051

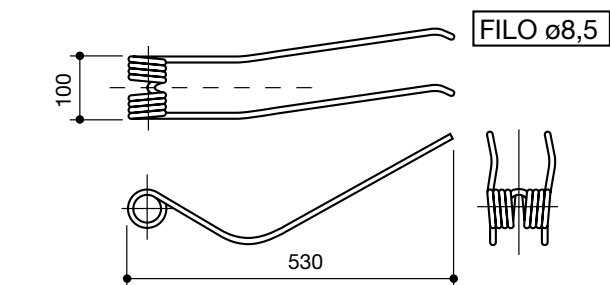

REPOSSI
3° tipo

LS30052

848

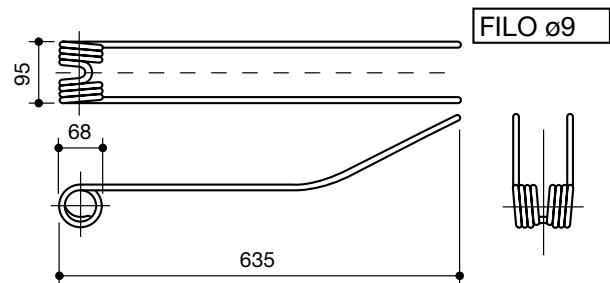

REPOSSI
4° tipo

LS30053

R61

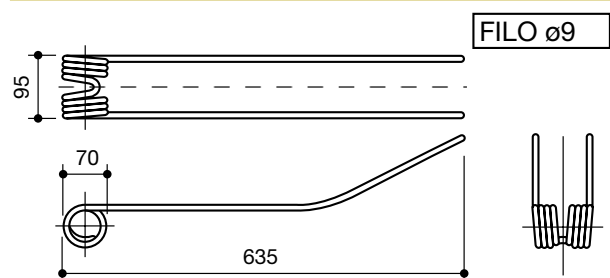

REPOSSI
5° tipo

LS30054

R61A

denti giroandatore
tines for windrowers

denominazione
denomination

rif.
la spirale

rif.
originale

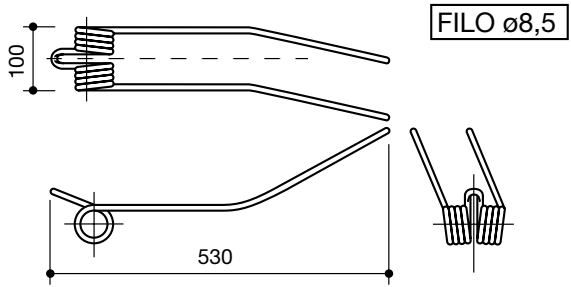

SAMA
corto 1° tipo

LS30055

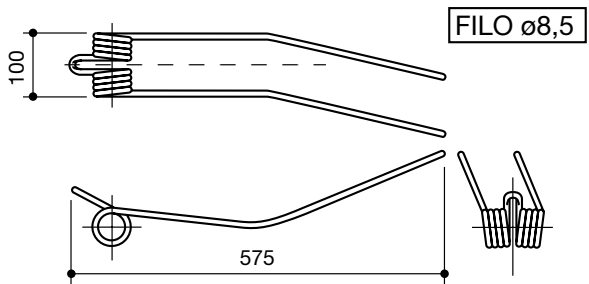

SAMA
2° tipo

LS30056

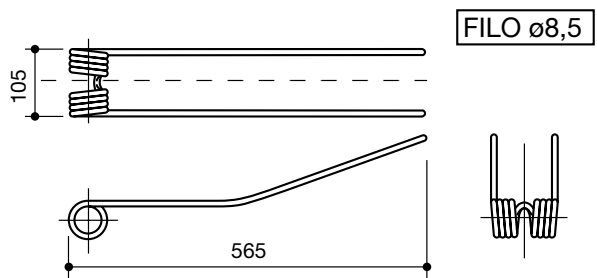

SAMA
3° tipo

LS30057

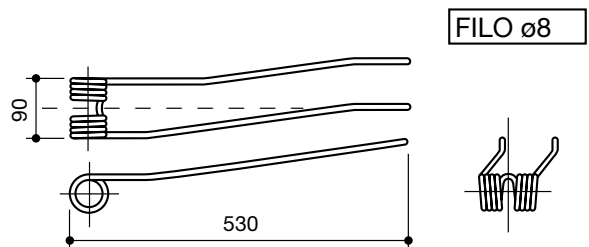

SUPERMIXER
destro

LS30058

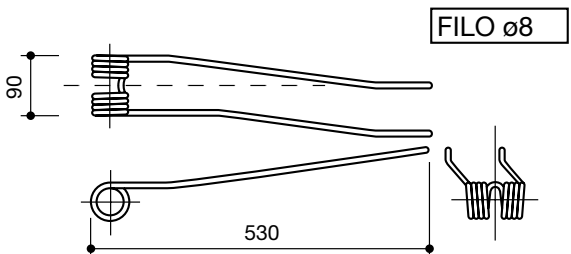

SUPERMIXER
sinistro

LS30059

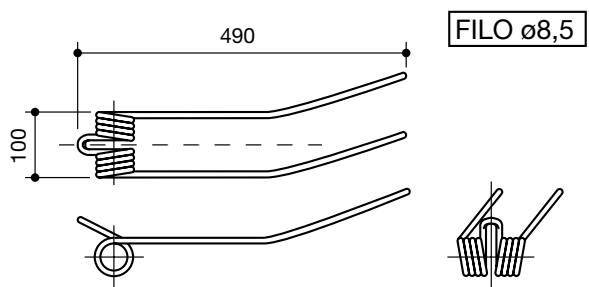

SLAM
GIRORAMI
destro

LS30060

denti giroandatore
tines for windrowers

denominazione
denomination

rif.
la spirale

rif.
originale

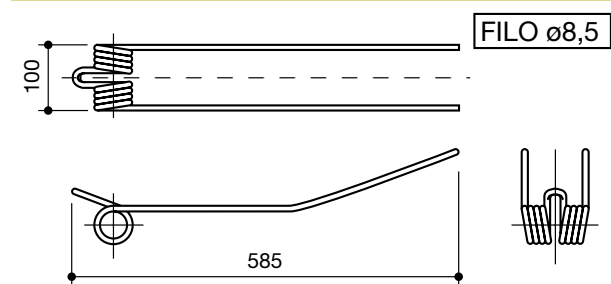

SLAM
lungo

LS30061

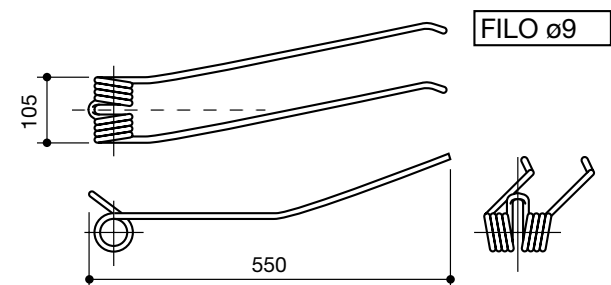

SLAM
piegato

LS30062

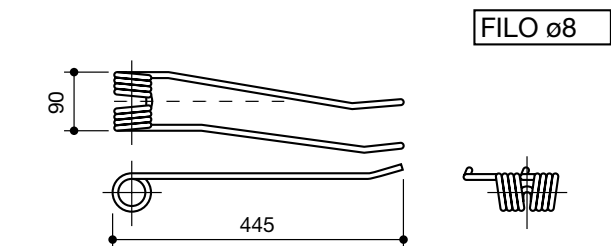

STOLL
sinistro

LS30063

0124200

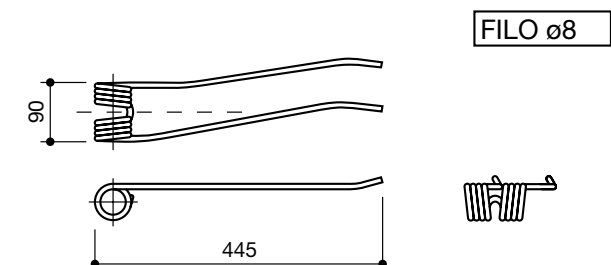

STOLL
destro

LS30064

0292960

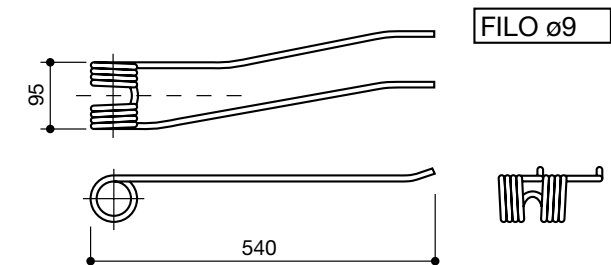

STOLL

LS30065

0606810

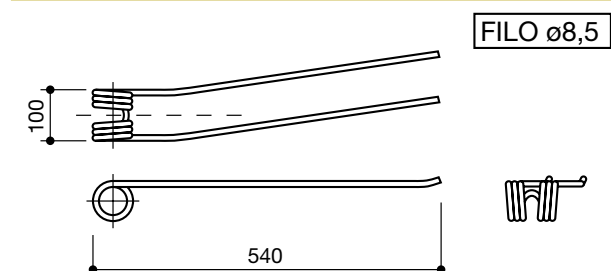

STOLL

LS30066

0606811

denti giroandatore
tines for windrowers

denominazione
denomination

rif.
la spirale

rif.
originale

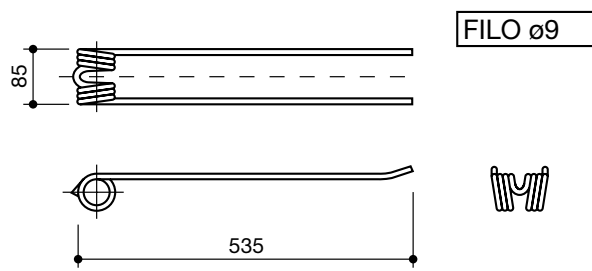

STOLL

LS30067

0621811

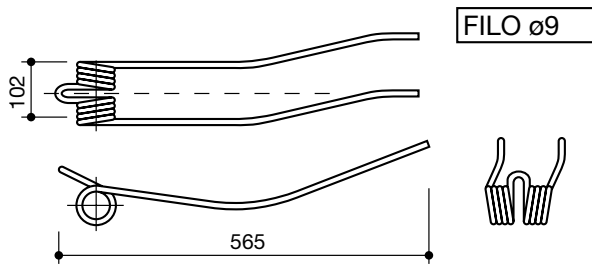

WOLVO

LS30068

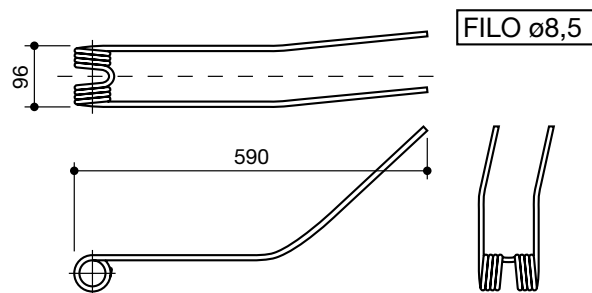

ACMA

LS30069

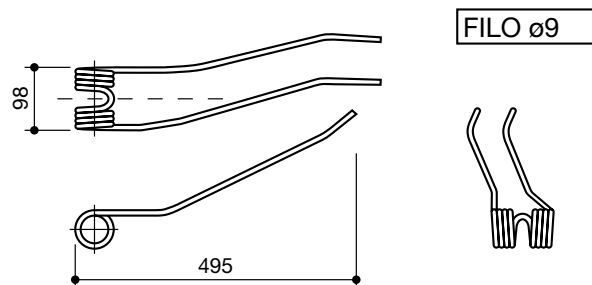

POTTINGER

LS30070

436141

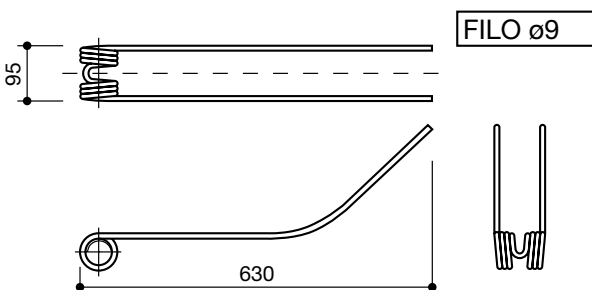

OTMA

LS30071

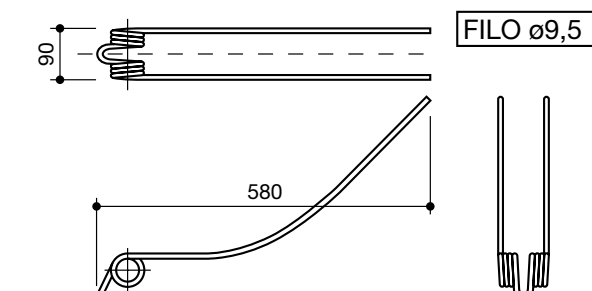

FELLA

LS30072

160111

denti giroandatore
tines for windrowers

denominazione
denomination

rif.
la spirale

rif.
originale

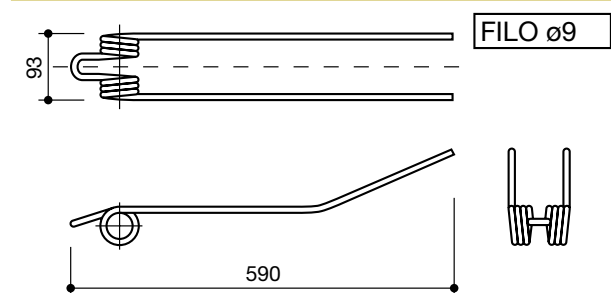

PZ ANDEX

LS30073

PZ356

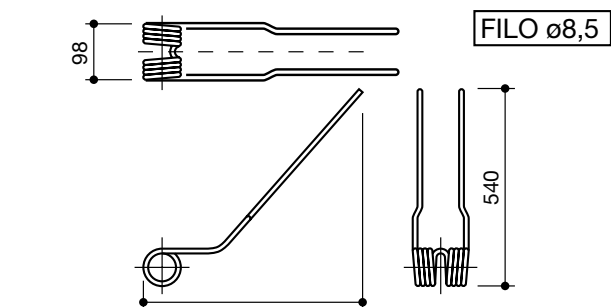

SIP

LS30074

153932908

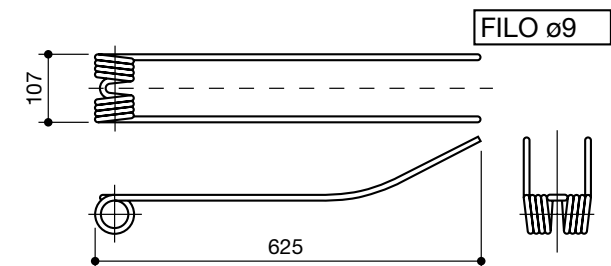

DA ROS

LS30075

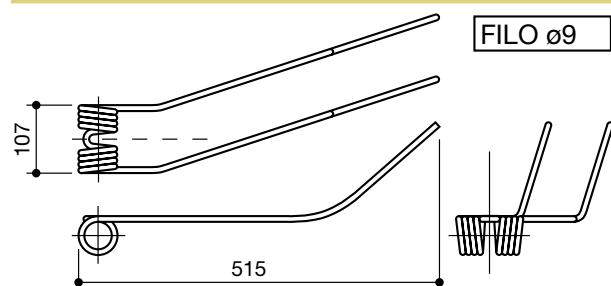

F.C.R.

LS30076

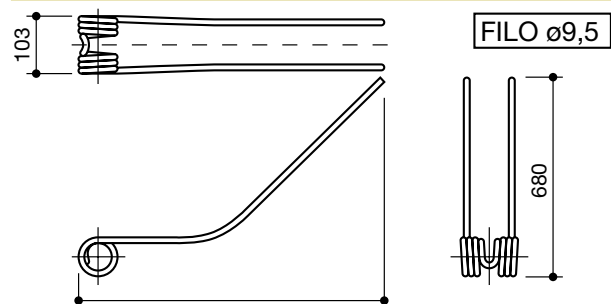

GALFRÈ
2000

LS30077

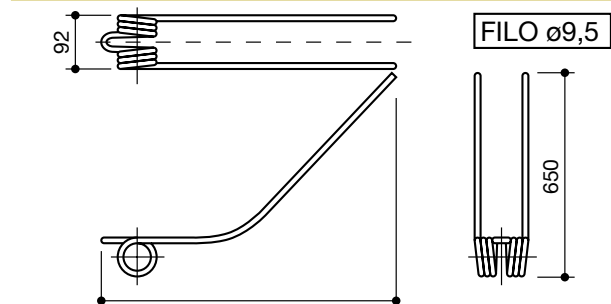

KUHN
lungo

LS30078

denti giroandatore
tines for windrowers

denominazione
denomination

rif.
la spirale

rif.
originale

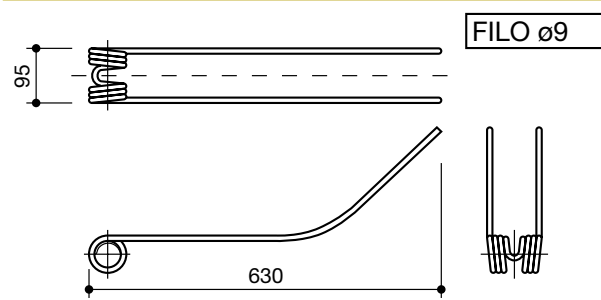

OLIVI
2° tipo

LS30079

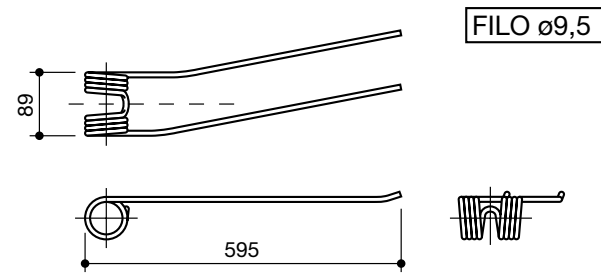

POTTINGER

LS30080

238060151

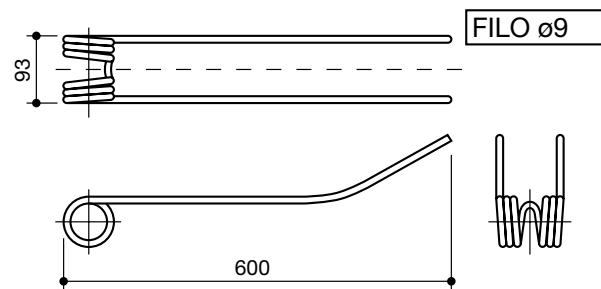

LELY
2° tipo

LS30081

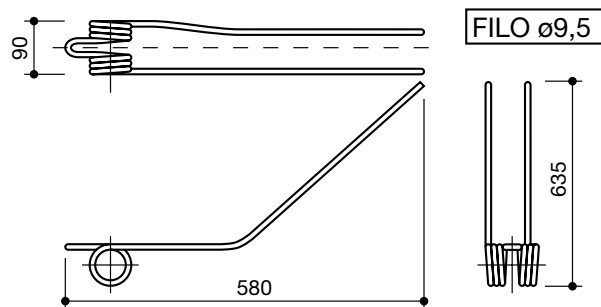

KRONE

LS30082

1536610

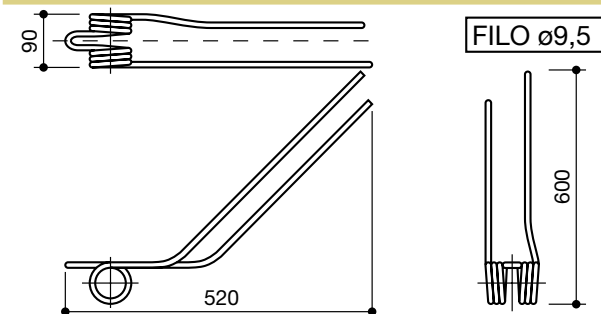

KRONE

LS30083

1536620

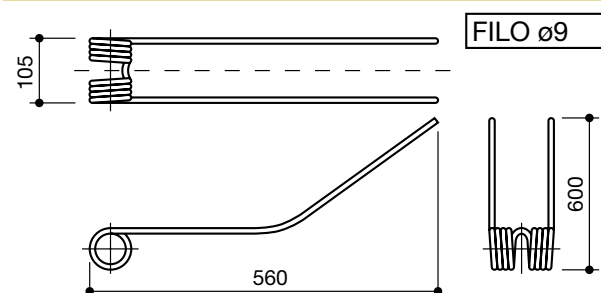

CORMA

LS30084

denti giroandatore
tines for windrowers

denominazione
denomination

rif.
la spirale

rif.
originale

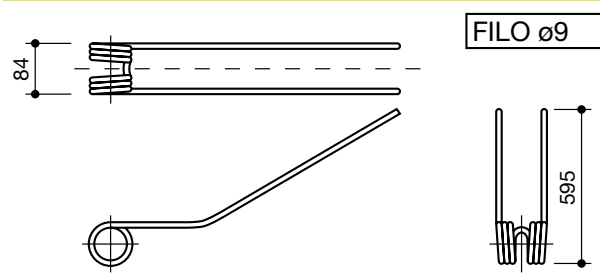

POTTINGER

LS30085

436033

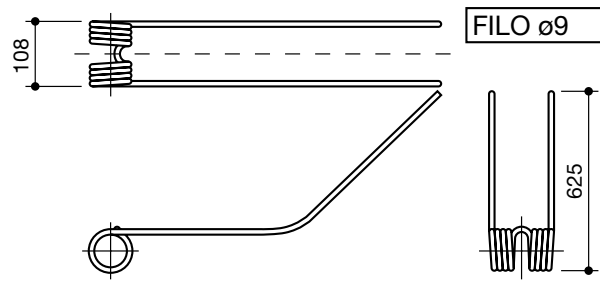

ABA GROUP

LS30086

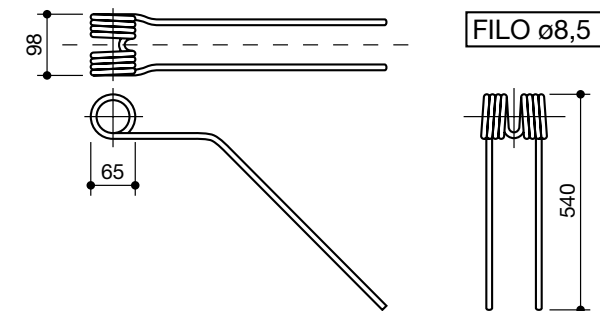

KRONE

LS30087

2690420

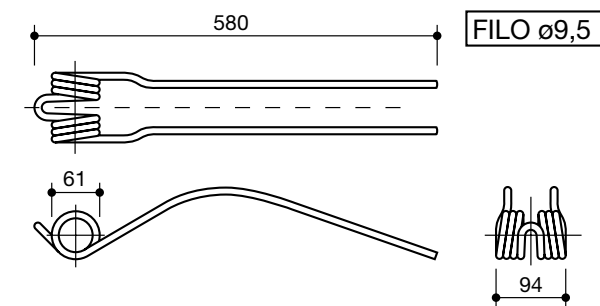

FELLA

LS30088

162058

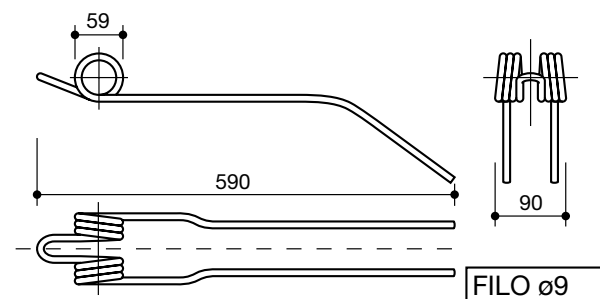

FAHR

LS30089

16600387

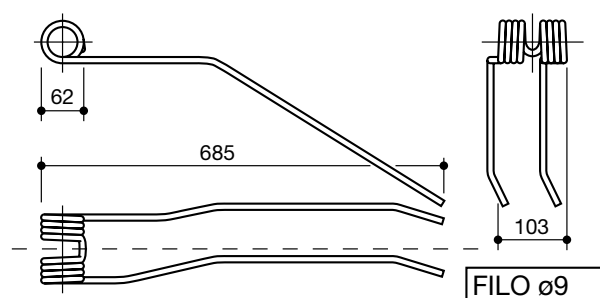

FONTANESI
3° tipo

LS30090

denti giroandatore
tines for windrowers

denominazione
denomination

rif.
la spirale

rif.
originale

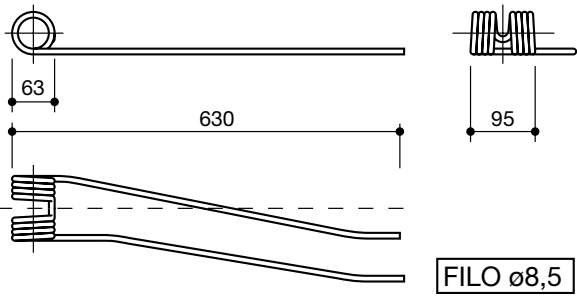

BORELLO
lungo sinistro

LS30091

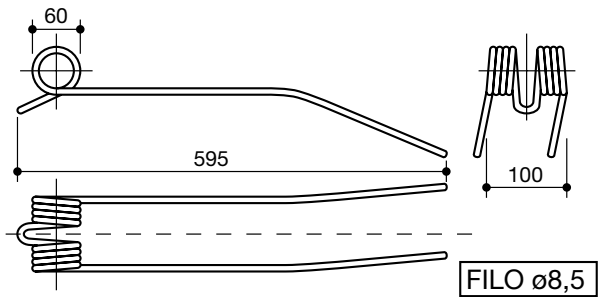

MORRA
3° tipo

LS30092

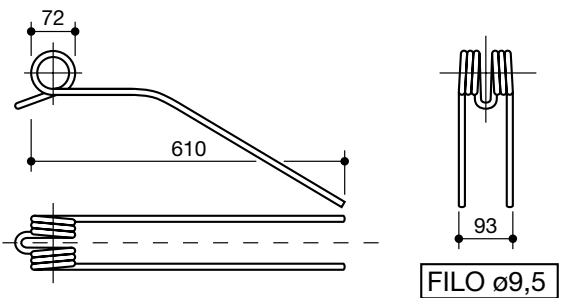

KUHN

LS30093

57562500
K8013670

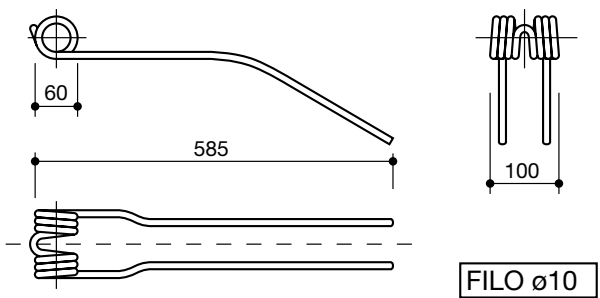

STOLL
M800

LS30094

031628400

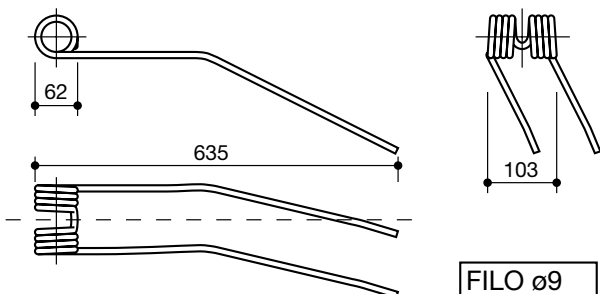

FONTANESI
4° tipo

LS30095

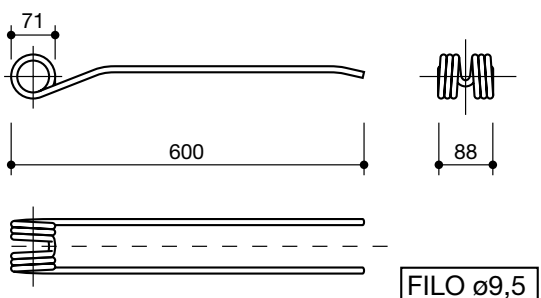

CLAAS
3° tipo

LS30096

955710

denti giroandatore
tines for windrowers

denominazione
denomination

rif.
la spirale

rif.
originale

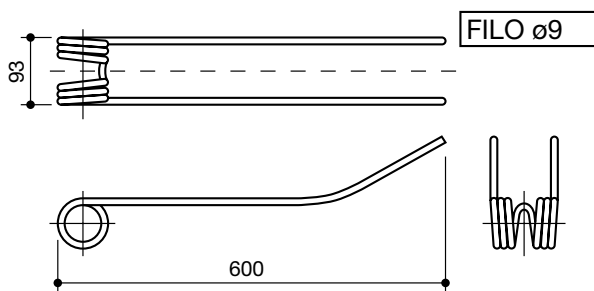

VICON

LS30097

16606394

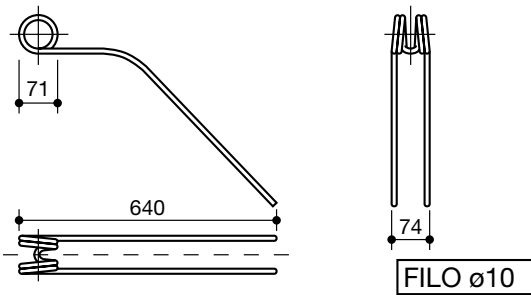

KRONE
SWADRO

LS30098

2684050
2680850

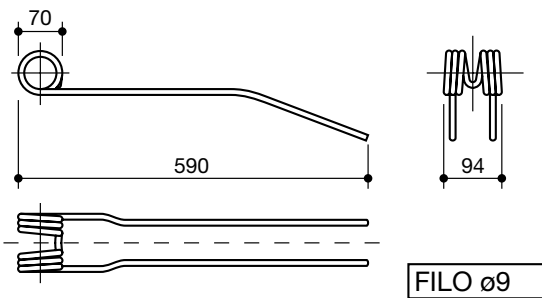

VICON

LS30099

VF1664486386

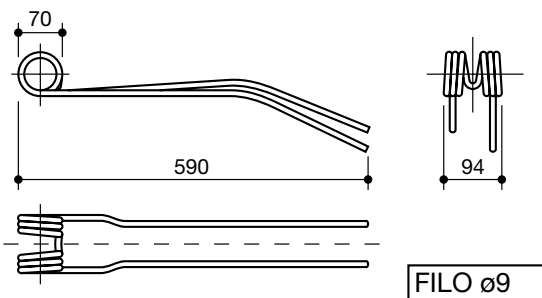

KVERNELAND

LS30100

16624288
16624214

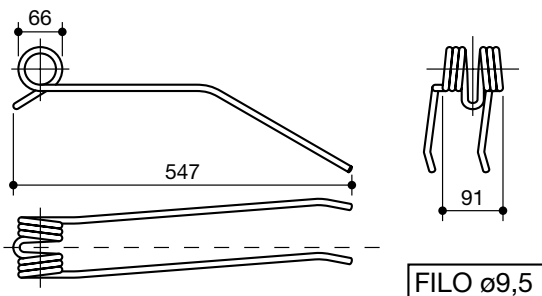

TONUTTI

LS30101

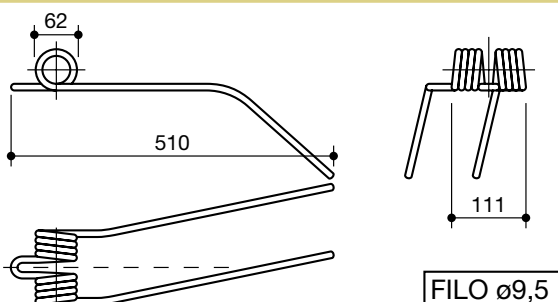

FCR

LS30102

denti giroandatore
tines for windrowers

denominazione
denomination

rif.
la spirale

rif.
originale

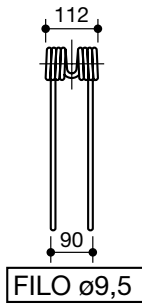
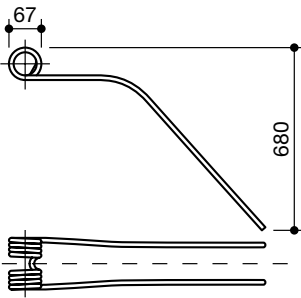

GALFRÈ
2015

LS30103

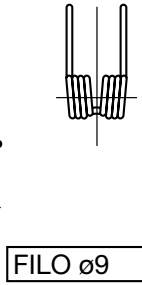
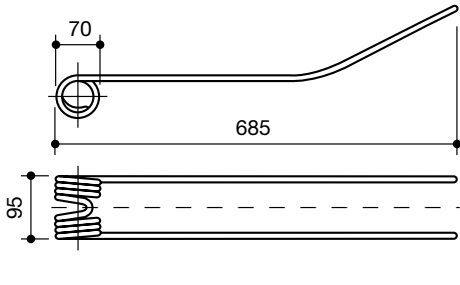

REPOSSI
6° tipo

LS30104

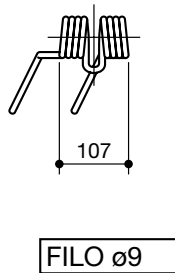
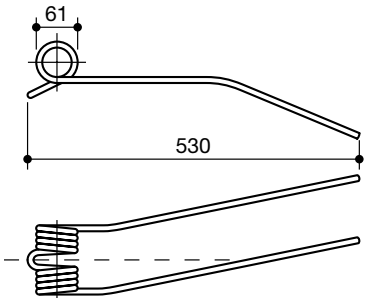

BORELLO
GIRORAMI
destro

LS30105

0086.0

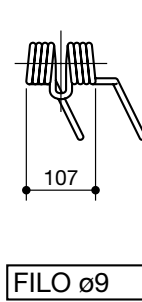
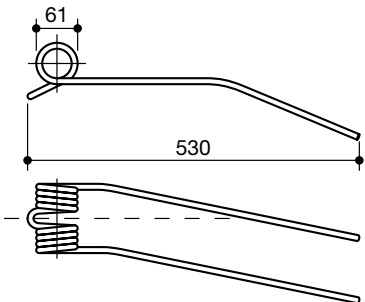

BORELLO
GIRORAMI
sinistro

LS30106

1086.0

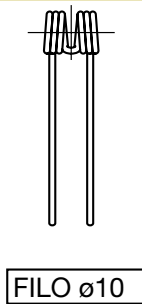
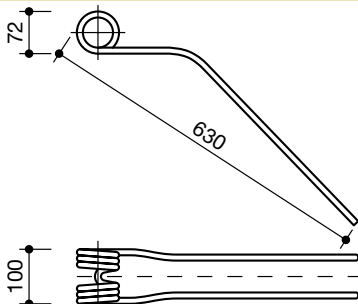

KRONE

LS30107

200428390

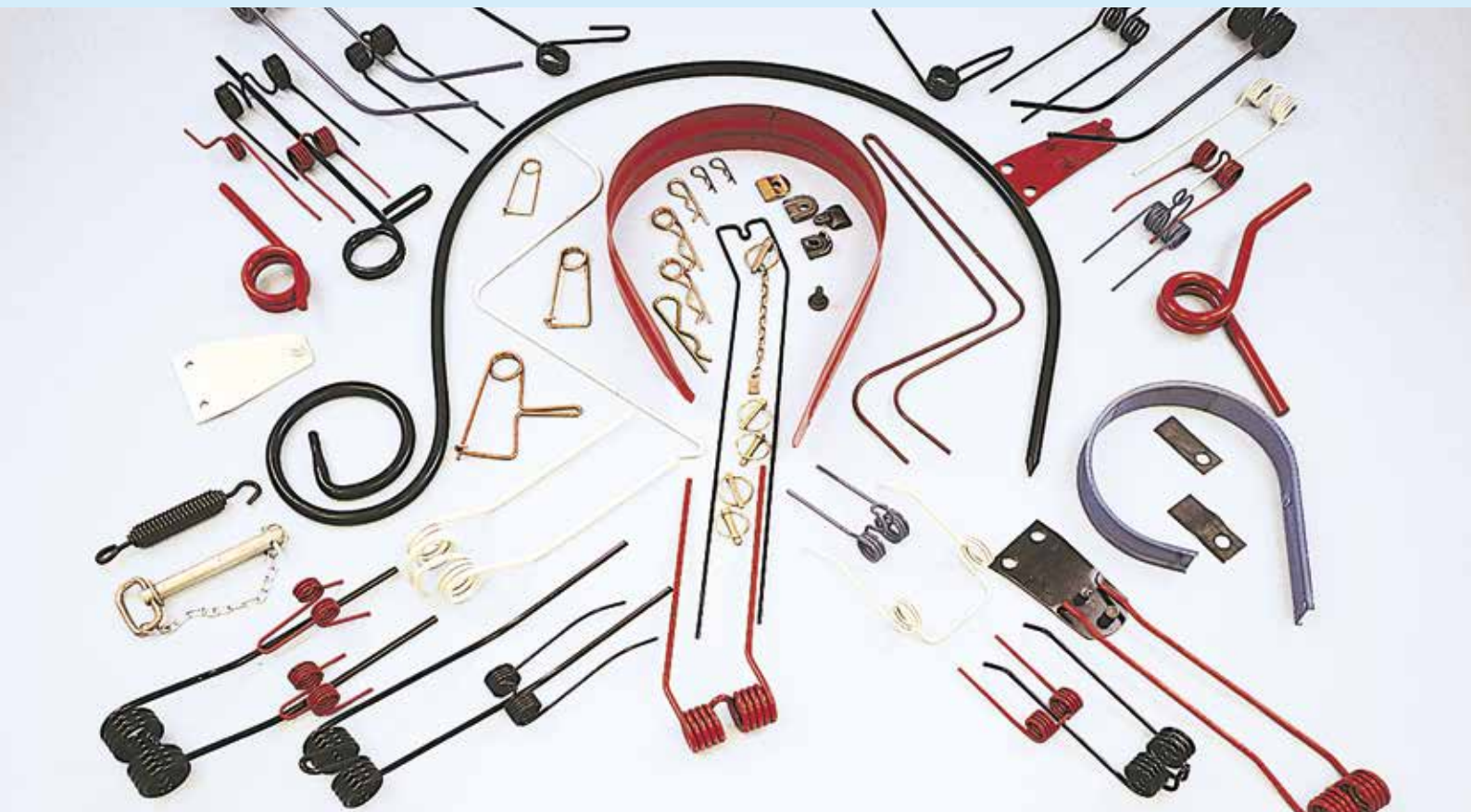

LA SPIRALE srl
via Milano, 8 - 20084 Lacchiarella (MI) - ITALY
tel. +39 02 90076666 +39 02 9008095
fax +39 02 9007338
www.laspiralemolle.it - e-mail: laspirale@tin.it