

Denti rastrelliera giroandatore

Tines for hay rakes

Dents pour rateaux

Federzinken für rechwender

Muelles para rastrillos

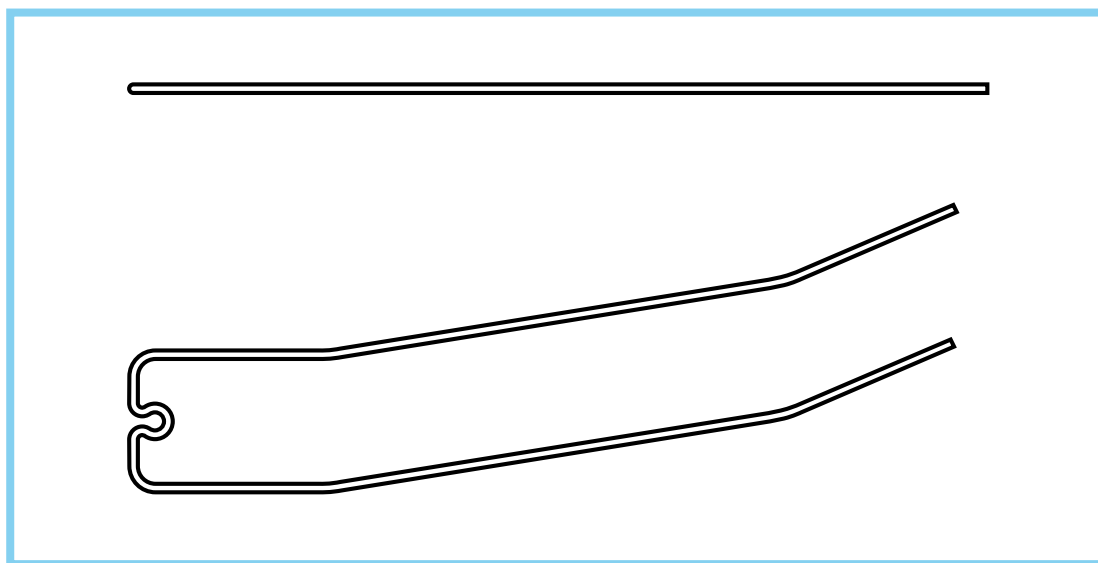

denti rastrelliera giroandatore
tines for hay rakes

denominazione
denomination

rif.
la spirale

rif.
originale

35

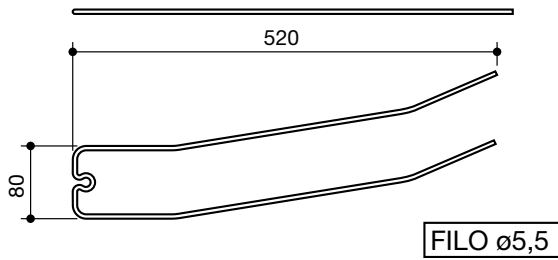

BCS

LS35001

8025

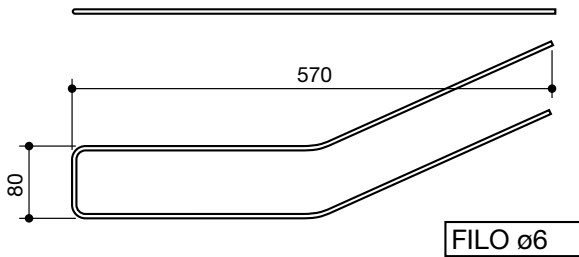

**CLAAS
BAUTZ**

LS35002

9021111

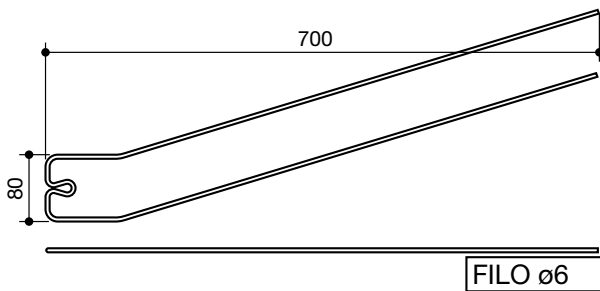

GALFRÈ

LS35003

49

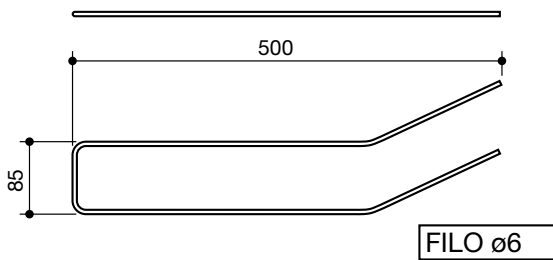

IMA
1° tipo

LS35004

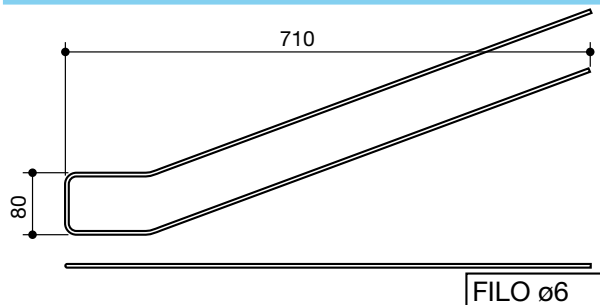

IMA
2° tipo

LS35005

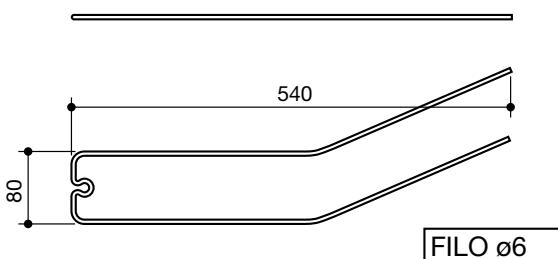

REPOSSI

LS35006

denti rastrelliera giroandatore
tines for hay rakes

denominazione
denomination

rif.
la spirale

rif.
originale

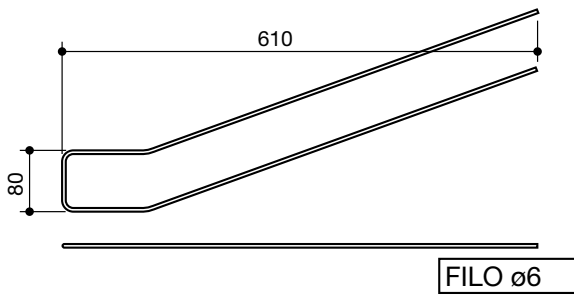

SLAM

LS35007

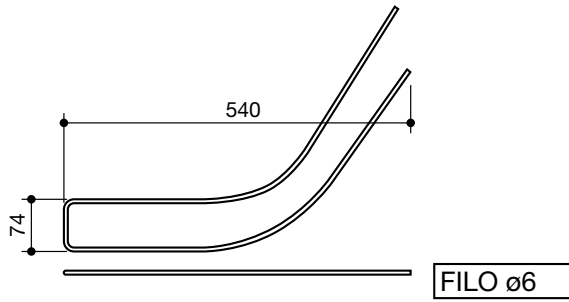

**CLAAS
BAUTZ**

LS35008

902111.1

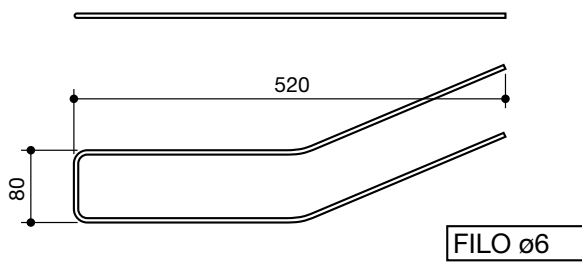

SAMA

LS35009

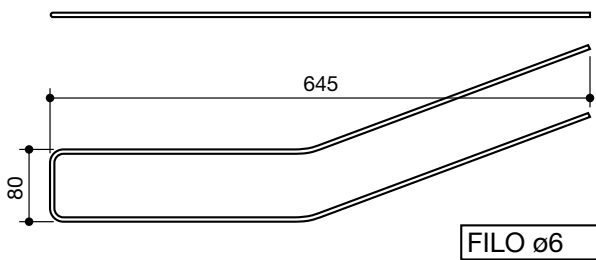

CIMAC

LS35010

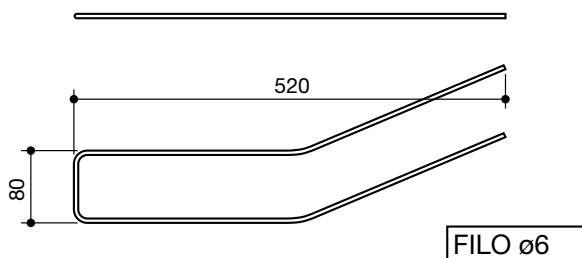

OTMA

LS35011

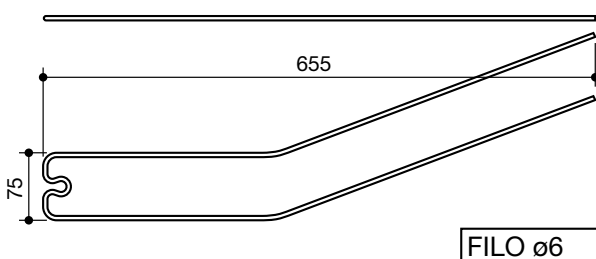

FCR

LS35012

denti rastrelliera giroandatore
tines for hay rakes

denominazione
denomination

ref.
la spirale

ref.
originale

35

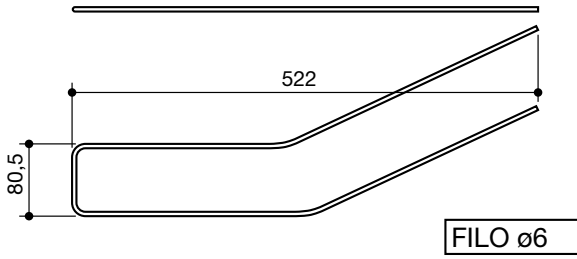

KUHN

LS35013

57502800