

Fasce rotopressa raccoglitrice

Bands for pick up round balers

Separateurs pour presses à balles rondes

Abstreiferr für rundballen pressen

Costillas para rotoempacadoras

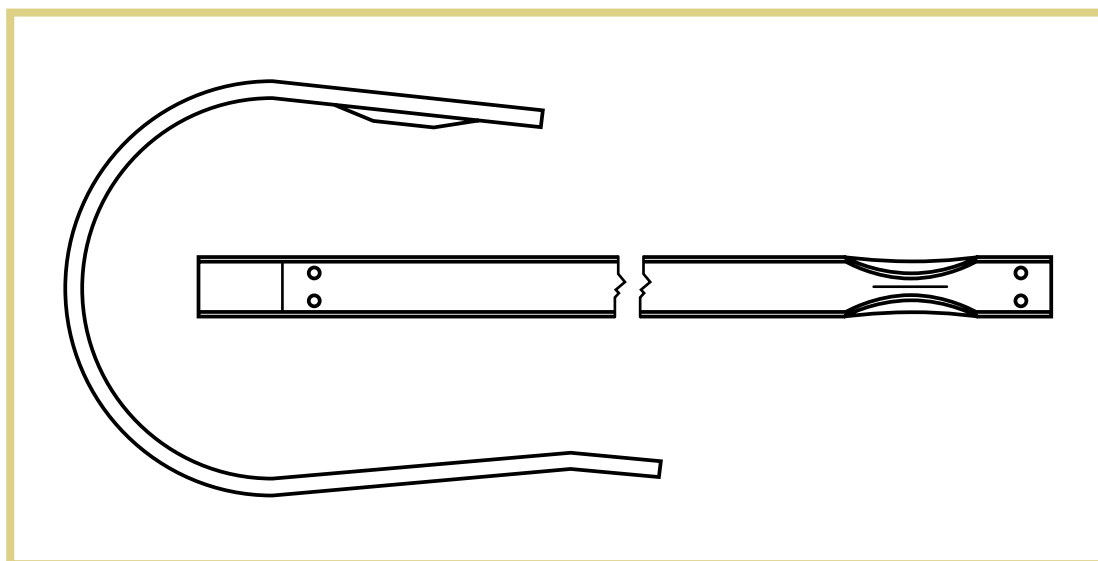

fasce rotopressa raccoglitrice
bands for pick up round balers

denominazione
denomination

rif.
la spirale

rif.
originale

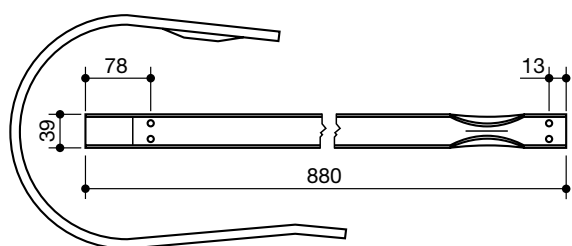

AMA

LS65001

2005031

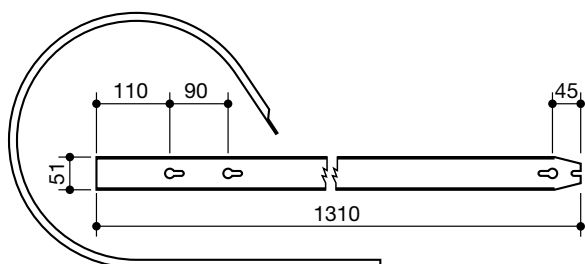

CLAAS
ROLLANT 62

LS65002

8191641

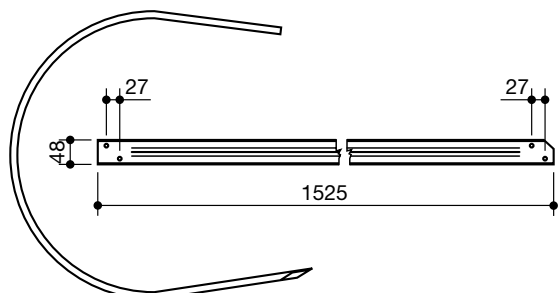

FAHR

LS65003

VF06550053

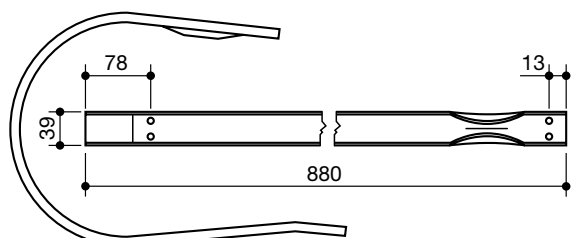

FORT

LS65004

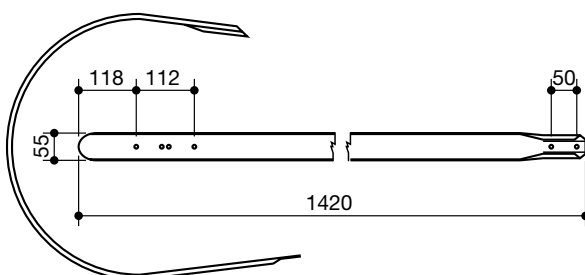

GALLIGNANI
1° tipo

LS65005

5305041

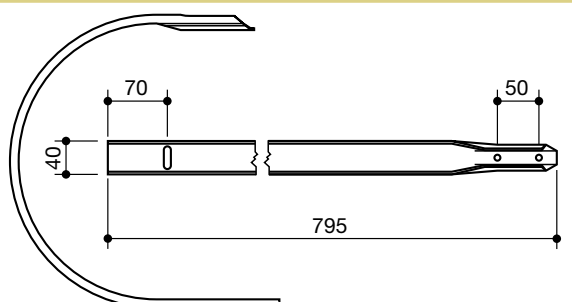

GALLIGNANI
2° tipo

LS65006

3105556

fasce rotopressa raccoglitrice
bands for pick up round balers

denominazione
denomination

rif.
la spirale

rif.
originale

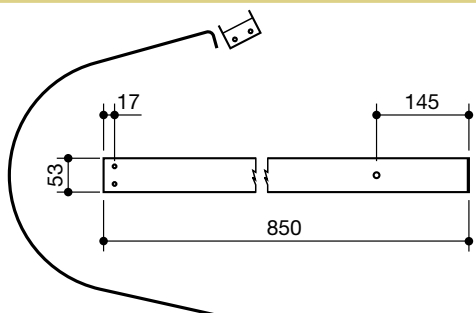

KRONE
1° tipo

LS65007

9379633

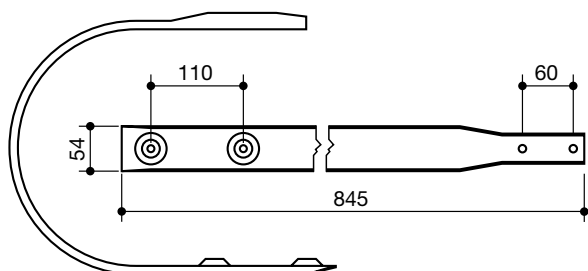

KRONE
125 2° tipo

LS65008

9381320

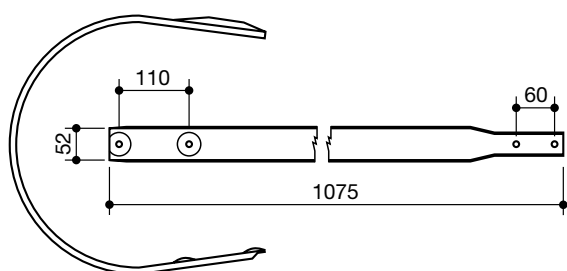

KRONE
150 3° tipo

LS65009

9381570

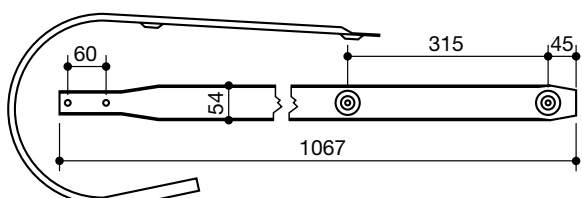

KRONE
160 lunga

LS65010

9381980

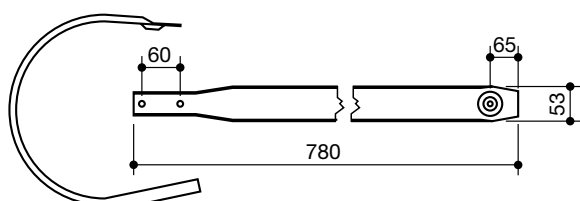

KRONE
160 corta

LS65011

9381970

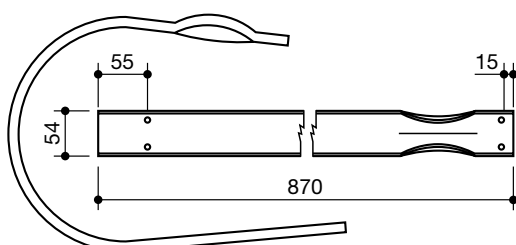

MORRA

LS65012

00000145033

fasce rotopressa raccoglitrice
bands for pick up round balers

denominazione
denomination

rif.
la spirale

rif.
originale

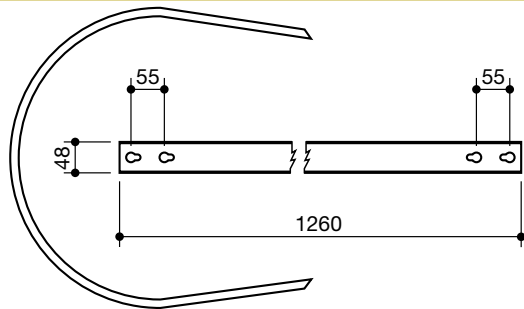

NEW HOLLAND

LS65013

799024

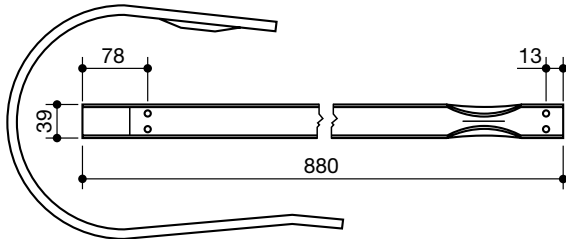

SANTINI

LS65014

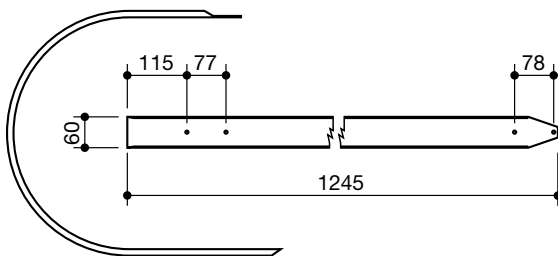

SGORBATI

LS65015

111600161

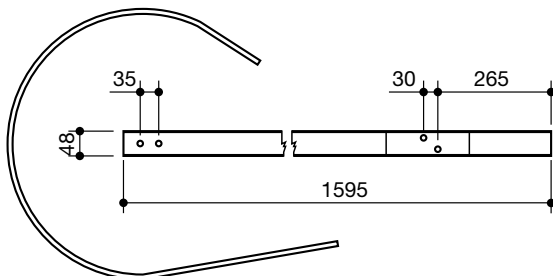

WELGER
180A

LS65016

1701420501

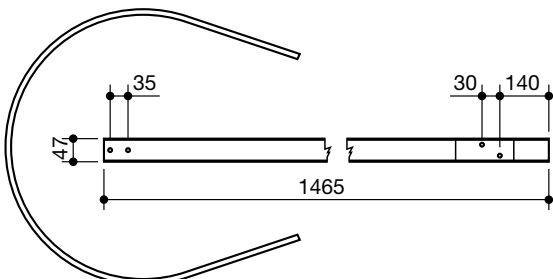

WELGER
180B

LS65017

1702420501

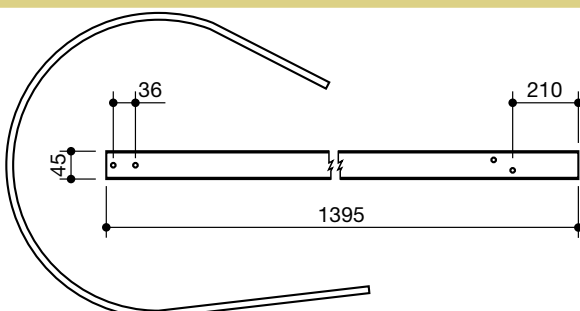

WELGER
RP150

LS65018

1705420508

fasce rotopressa raccoglitrice
bands for pick up round balers

denominazione
denomination

rif.
la spirale

rif.
originale

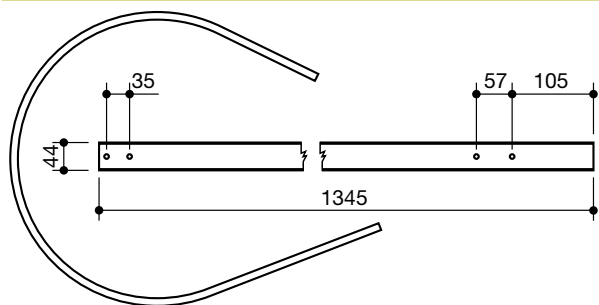

WELGER
RP15

LS65019

1712420504

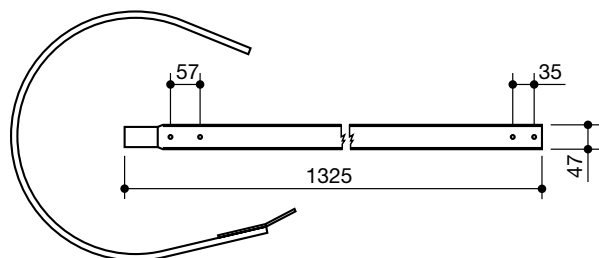

WELGER
RP15S

LS65020

1712420505

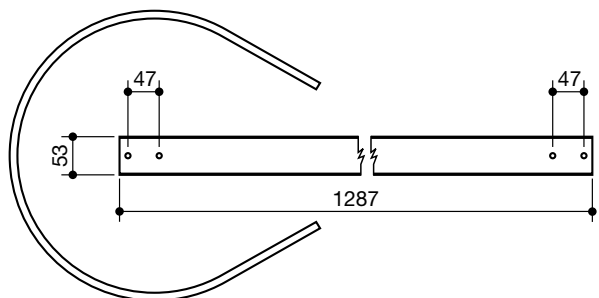

WERNER

LS65021

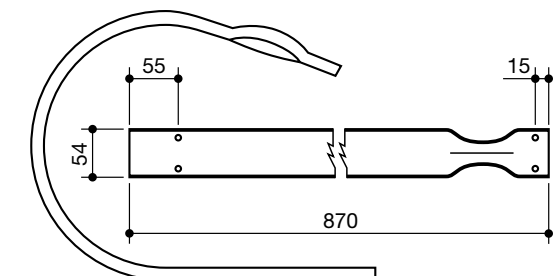

WOLVO

LS65022

12R001

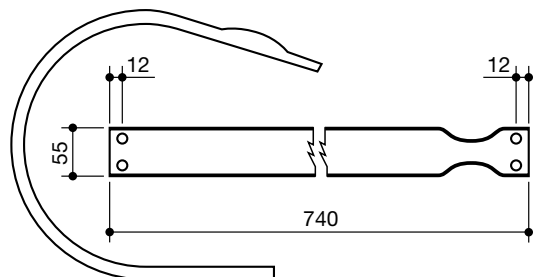

FERABOLI
1° tipo

LS65023

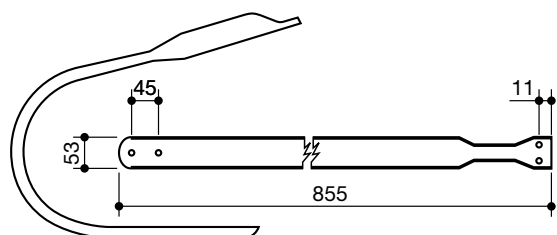

JOHN DEERE

LS65024

E65648

fasce rotopressa raccogliatrice
bands for pick up round balers

denominazione
denomination

**rif.
la spirale**

**rif.
originale**

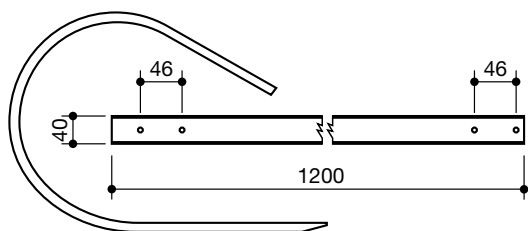

FAHR
2° tipo centrale

LS65025

06577405

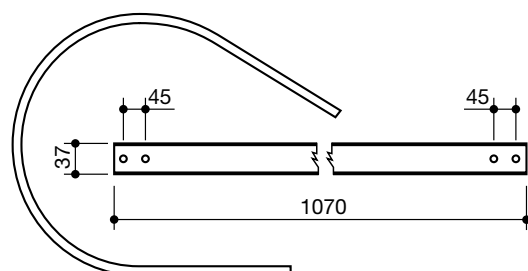

FAHR
2° tipo laterale
GR1200

LS65026

16514536

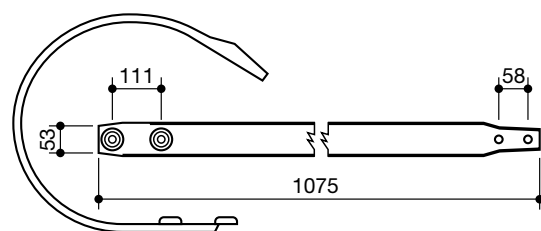

KRONE
130 destra

LS65027

9381630

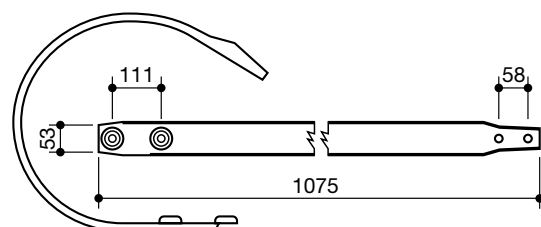

KRONE
130 sinistra

LS65028

9381640

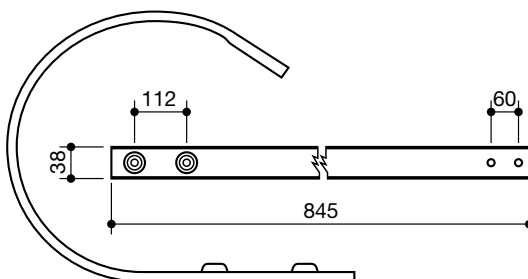

KRONE
130S centrale

LS65029

9382810

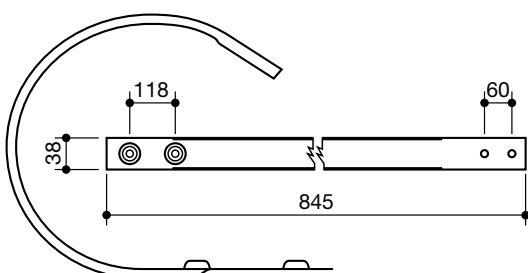

KRONE
130S laterale

LS65030

9382670

fasce rotopressa raccoglitrice
bands for pick up round balers

denominazione
denomination

rif.
la spirale

rif.
originale

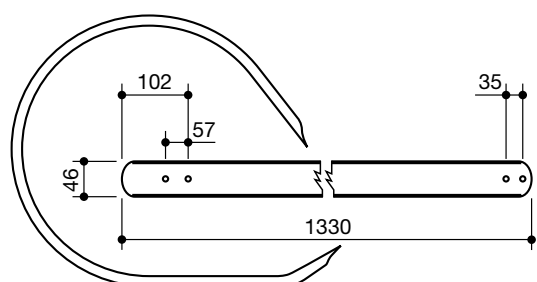

WELGER
RP200 grande

LS65031

1721420501

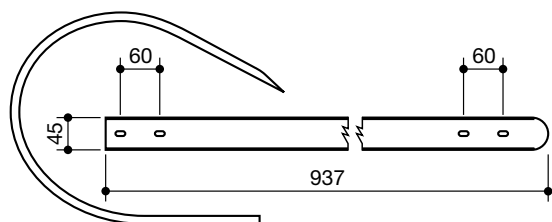

WELGER
RP200 piccola

LS65032

1211420502

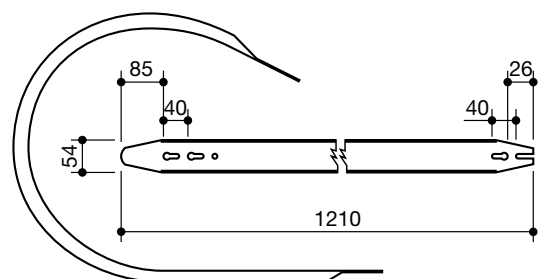

CLASS
66

LS65033

821439.2

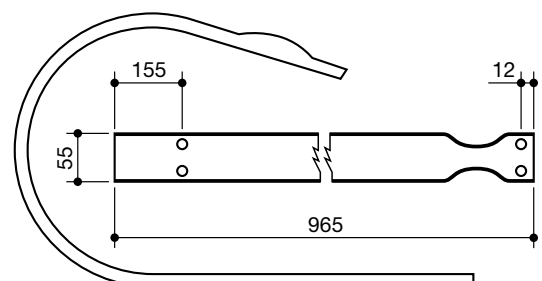

FERABOLI
2° tipo

LS65034

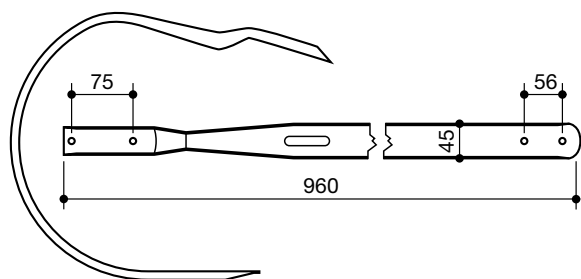

CLASS
VARIANT

LS65035

8261163
986434

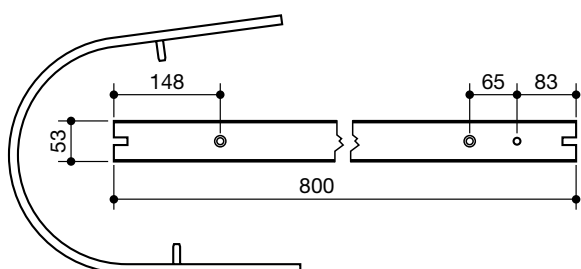

JOHN DEERE
TV

LS65036

AE24936

fasce rotopressa raccoglitrice
bands for pick up round balers

denominazione
denomination

rif.
la spirale

rif.
originale

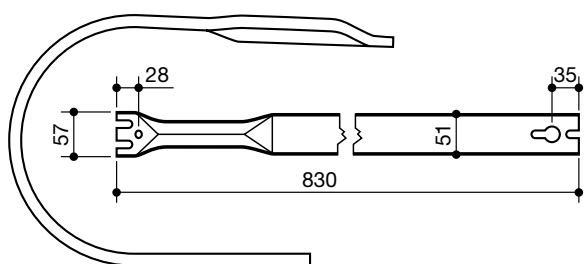

JOHN DEERE
TN

LS65037

CC32669

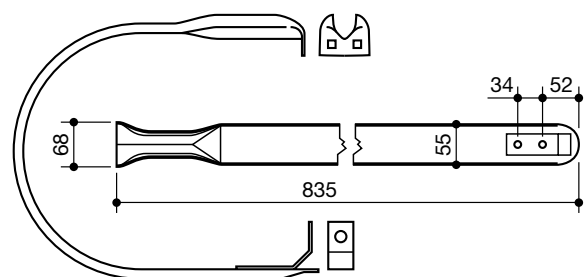

JOHN DEERE
trincia

LS65038

AZ15536

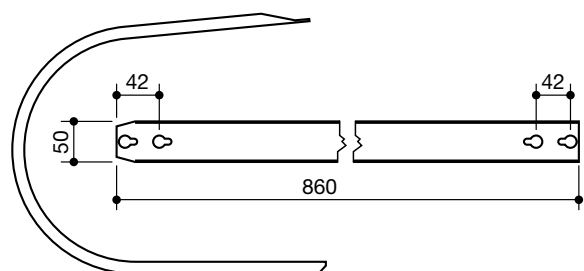

NEW HOLLAND

LS65039

86518442

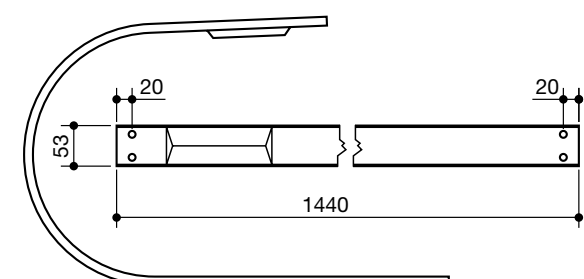

LERDA

LS65040

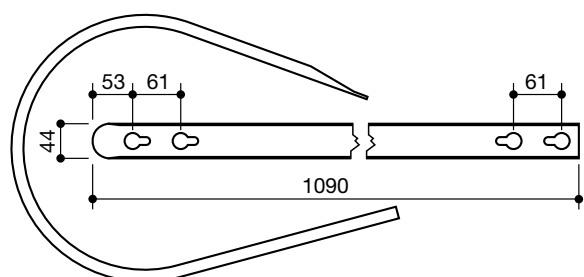

WELGER
RP320

LS65041

1257521502

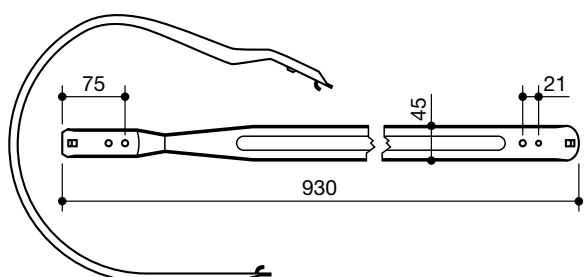

CLAAS
890

LS65042

09877700

fasce rotopressa raccoglitrice

bands for pick up round balers

denominazione

denomination

**rif.
la spirale**

**rif.
originale**

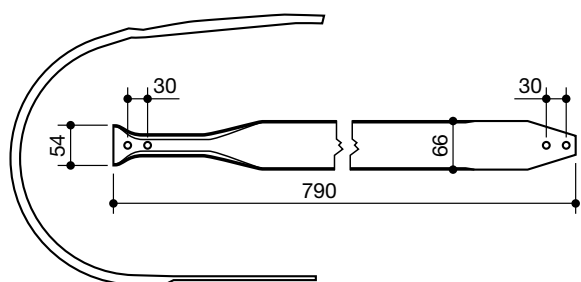

HESSTON

LS65043

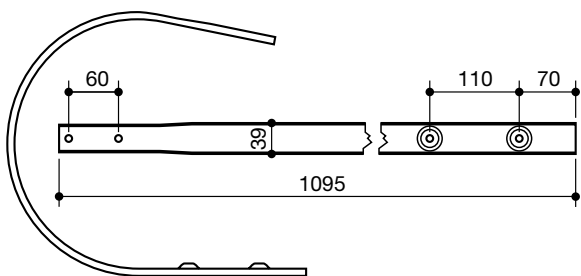

KRONE
1250 centrale

LS65044

9383100

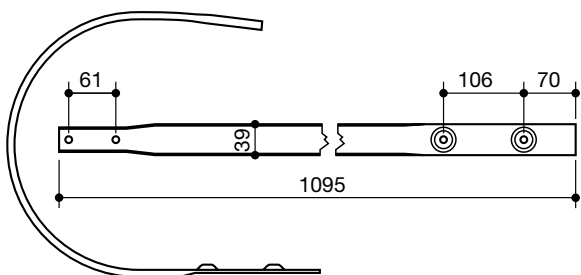

KRONE
1250 laterale

LS65045

9383110

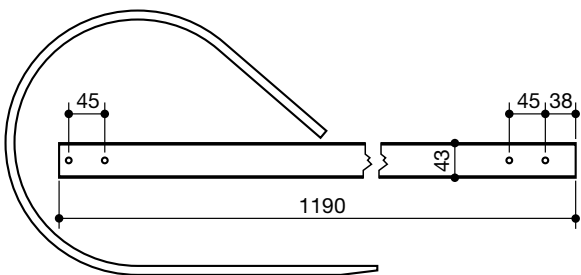

ORKEL
centrale

LS65046

58014

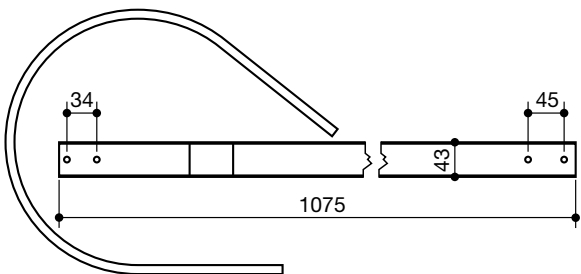

ORKEL
laterale

LS65047

58015

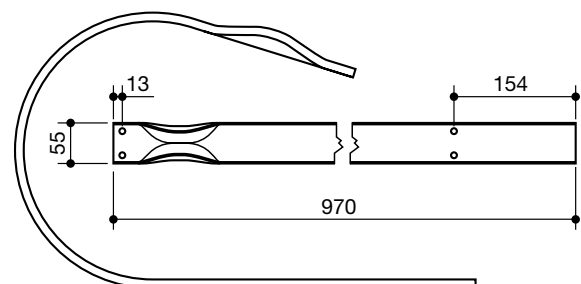

FERABOLI
lunga

LS65048

fasce rotopressa raccoglitrice
bands for pick up round balers

denominazione
denomination

rif.
la spirale

rif.
originale

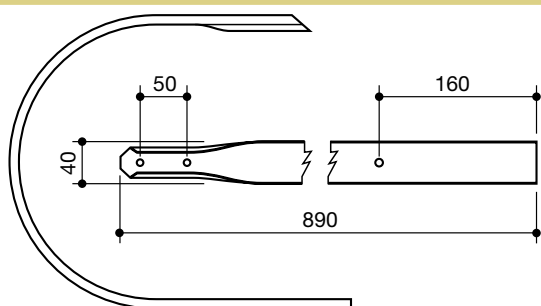

GALLIGNANI
3° tipo

LS65049

3405009

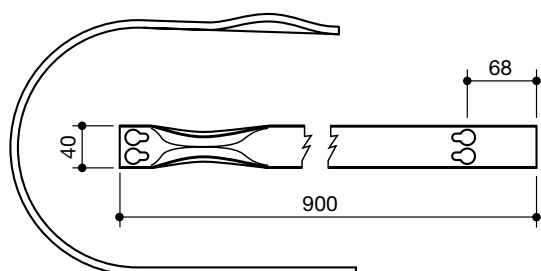

WOLVO
COMPACT

LS65050

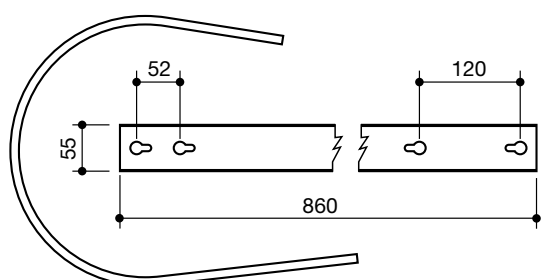

KRONE
KR150 2° tipo

LS65051

9380501

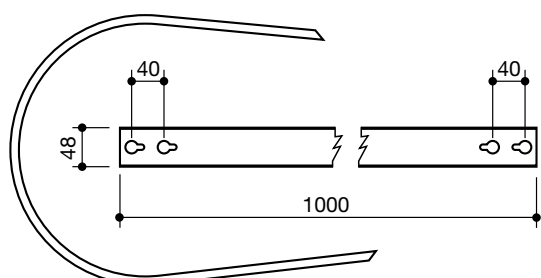

VICON

LS65052

VF16617244

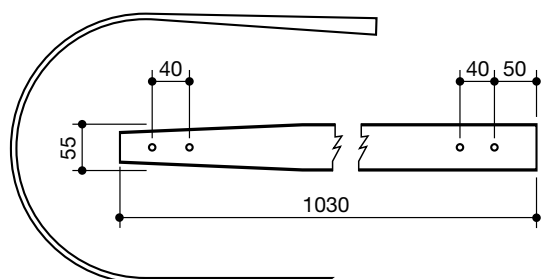

VICON

LS65053

B+28

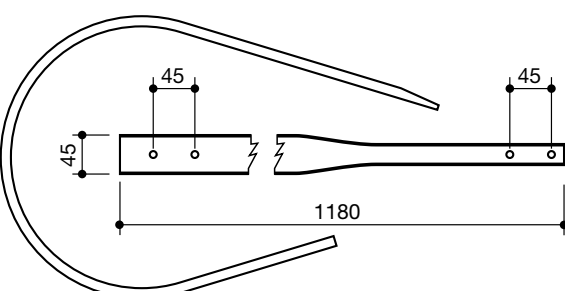

ORKEL

LS65054

58014

fasce rotopressa raccoglitrice
bands for pick up round balers

denominazione
denomination

rif.
la spirale

rif.
originale

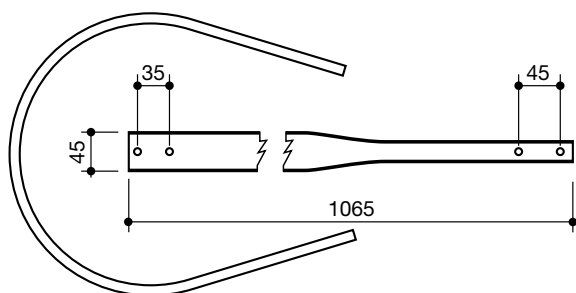

ORKEL

LS65055

58015

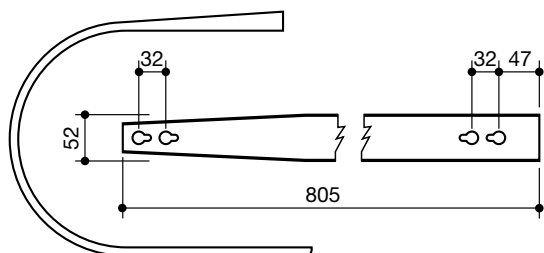

FERABOLI
centrale

LS65056

C003304

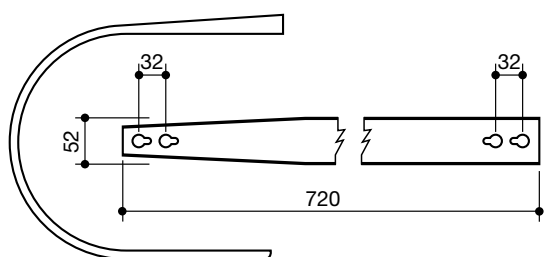

FERABOLI
laterale

LS65057

C003183

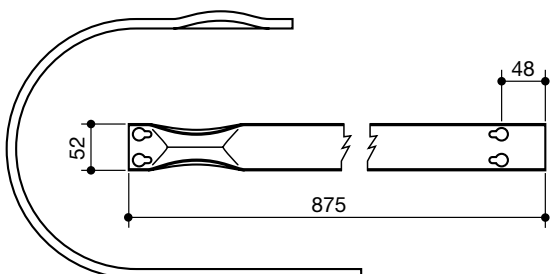

SUPERTINO

LS65058

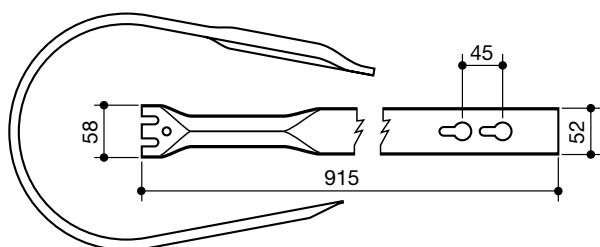

JOHN DEERE

LS65059

CC39857

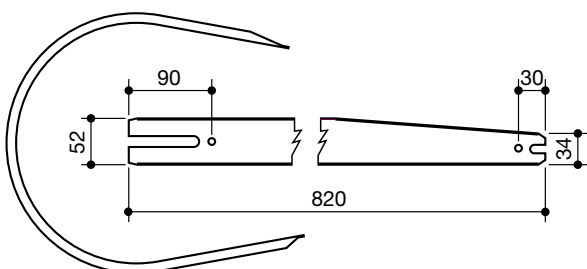

JF

LS65060

2065-623X

fasce rotopressa raccoglitrice
bands for pick up round balers

denominazione
denomination

rif.
la spirale

rif.
originale

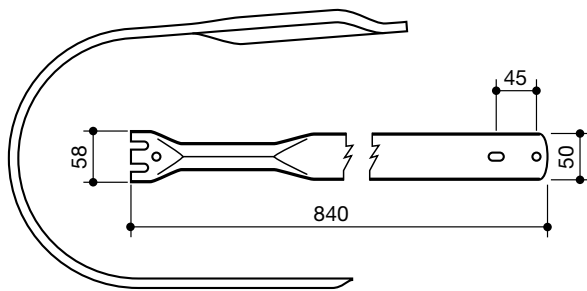

JOHN DEERE

LS65061

E88848

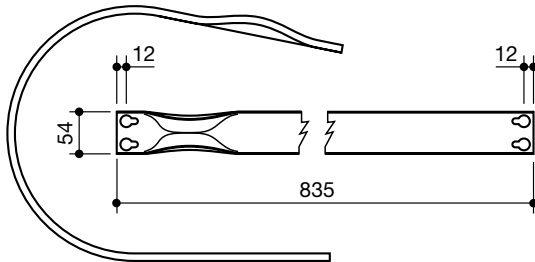

CARRARO

LS65062

500010

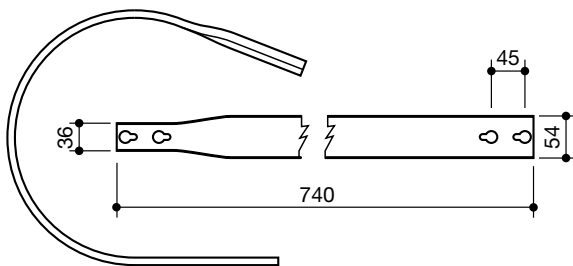

CARRARO

LS65063

08500219

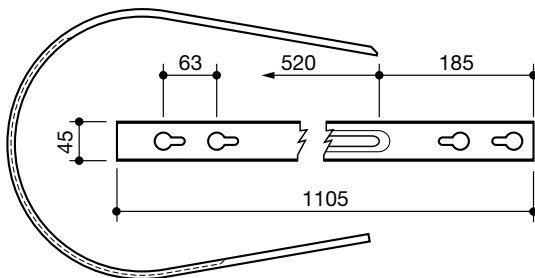

McHALE

LS65064

CTP00048

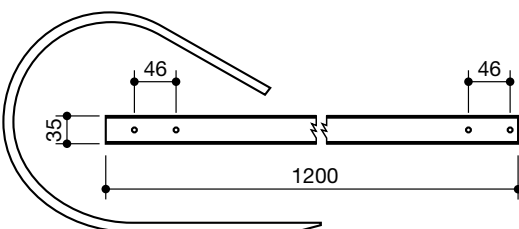

**FAHR
VICON**

LS65065

16617875

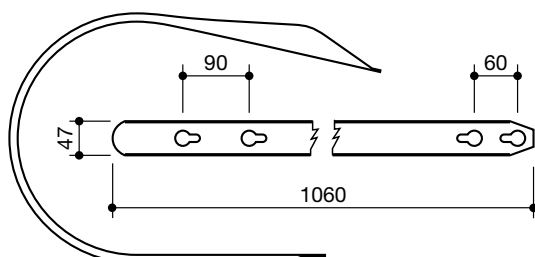

WELGER

LS65066

4896520548

fasce rotopressa raccoglitrice
bands for pick up round balers

denominazione
denomination

rif.
la spirale

rif.
originale

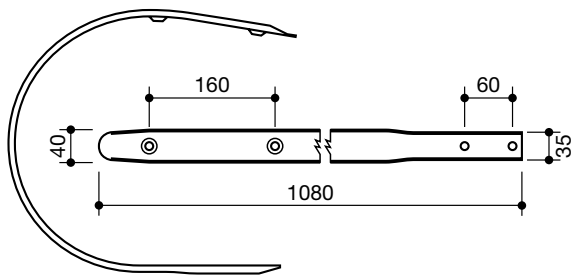

KRONE

LS65067

270024560

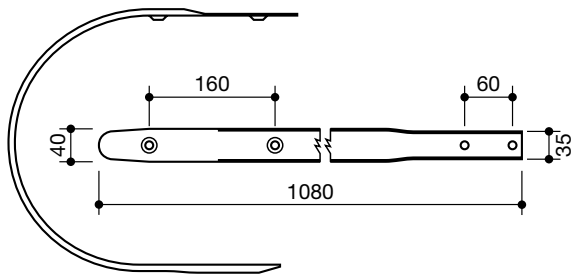

KRONE

LS65068

270064740

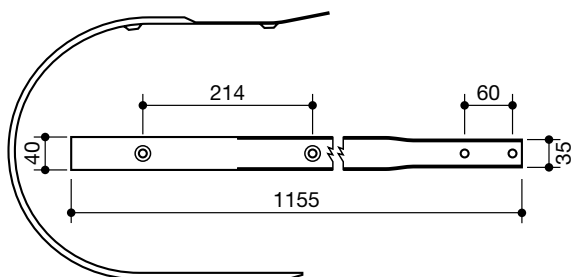

KRONE

LS65069

270074620

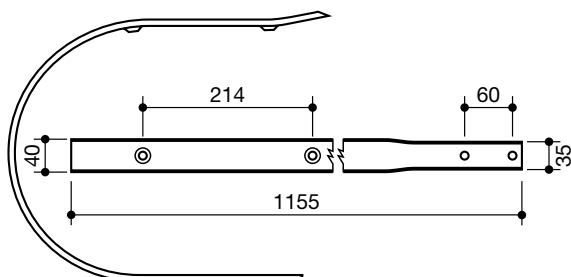

KRONE

LS65070

270056480

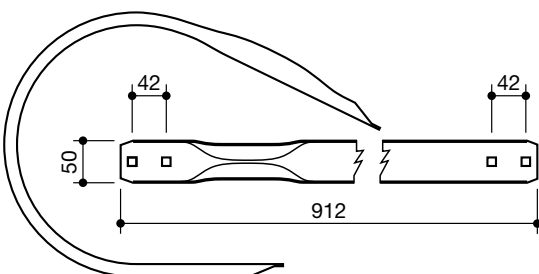

TAARUP

LS65071

59403000

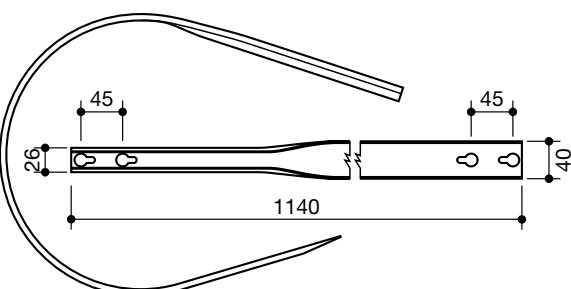

ORKEL

LS65072

58281

fasce rotopressa raccogliatrice
bands for pick up round balers

denominazione
denomination

rif.
la spirale

rif.
originale

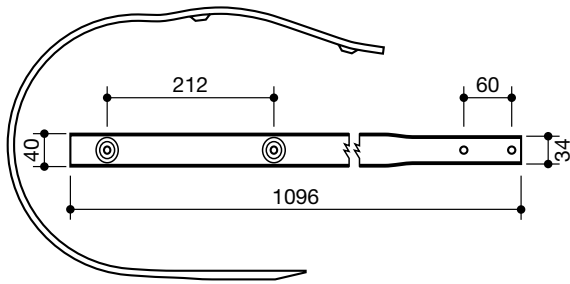

KRONE

LS65073

270002260

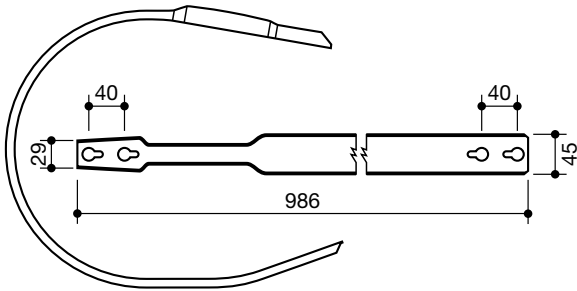

KUHN

LS65074

Z4523561

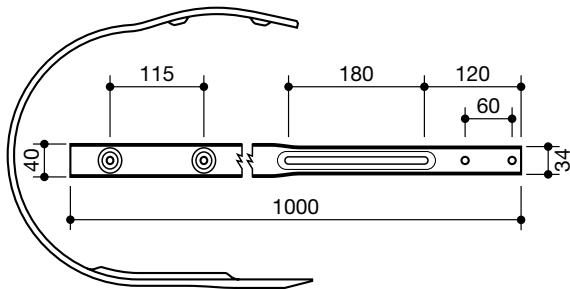

McHALE

LS65075

CTP00456

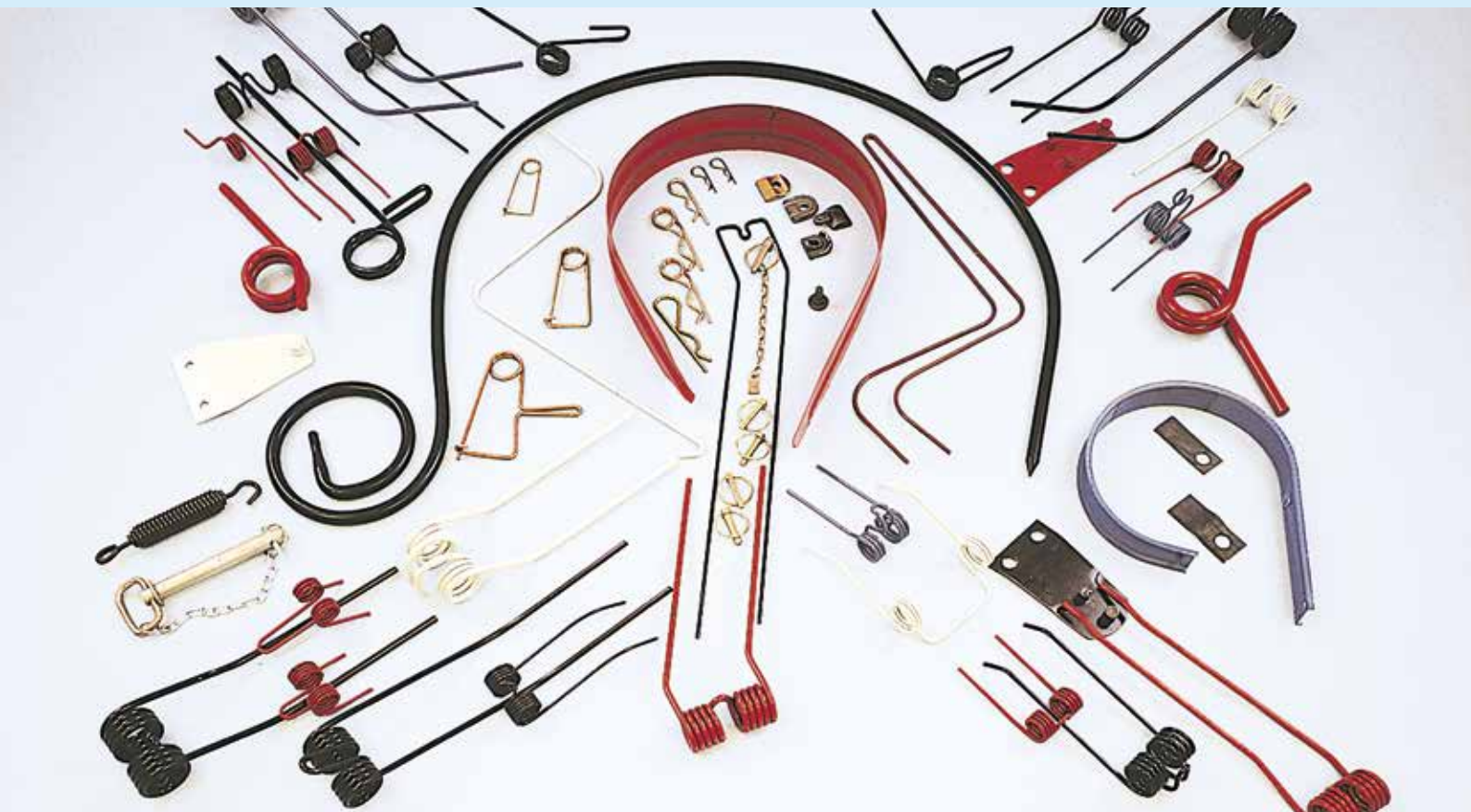

LA SPIRALE srl
via Milano, 8 - 20084 Lacchiarella (MI) - ITALY
tel. +39 02 90076666 +39 02 9008095
fax +39 02 9007338
www.laspiralemolle.it - e-mail: laspirale@tin.it